



Rolvax SURGICAL

Manufacturer & Exporter of Surgical Instruments

Table Of Contents

















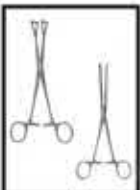
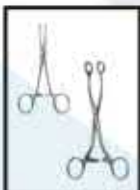
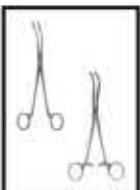
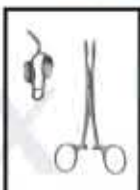

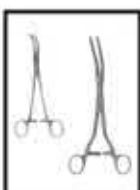

Diagnostic, Anaesthesia and other instruments	Page Seite		Probes, Pocket Instruments sets	Page Seite	
Diagnostyka, Anestezjologia, Narzędzia różne	1 - 10		Zgłębniki i zestawy narzędzi	66 - 68	
Scalpels, knives and Scalpel Handles			Wound Retractors		
Skalpele, nożyki i uchwyt do skalpeli	11 - 14		Haki do ran	69 - 80	
Scissors			Self-Retaining Retractors, Abdominal Retractors		
Nożyczki	15 - 31		Haki samo trzymające, haki brzuszne	81 - 85	
Dissecting-and Tissue Forceps			Abdominal Surgery Intestinal-and Rectal Instruments		
Pincety preparacyjne i chirurgiczne	32 - 42		Chirurgia brzuszna, narzędzia jelitowe i rektalne	86 - 93	
Sponge, Dressing and Tissue Grasping Forceps Towel Clamps			Gall Bladder-, Liver-and Spleen Instruments		
Pincety do tamponowania, anatomiczne, Chirurgiczne chwytające, spinaki	43 - 48		Narzędzia do kamieni żółciowych, wątroby, śledziony	94 - 96	
Vessel Clips, Bulldog Clamps Haemostatic Forceps			Genito-Urinary Instruments and Trocars		
Zaciski do naczyń, kłamyry typ Bulldog, Kleszczyki naczyniowe	49 - 57		Narzędzia urologiczne, trokary	97 - 100	
Ligature, Hysterectomy and Compression Forceps Vaginal Clamps			Vaginal Specula and Uterine Dilators		
Narzędzia do ligatury Narzędzia do macicy, kleszcze ściskające, kleszcze dopochwowe	58 - 60		Wzierniki ginekologiczne i rozszerzacze	101 - 106	
Needle Holders, Suture Instruments			Uterine Probes, Uterine Dressing-, Polypus-and Ovum Forceps		
Igłotrzymacze, narzędzia do szycia	61 - 65		Zgłębniki maciczne, kleszczyki do polipów i jajeczek	107 - 109	

Table Of Contents

	Page Seite		Page Seite	
Biopsy Instruments and Curettes				Suction Instruments
Narzędzia biopsyjne, łyżeczki	110 - 116			Narzędzia ssące
				158 - 166
Obstetrics and Tracheotomy				
Położnictwo i tracheotomia	117 - 119			
Cardiovascular-and Thoracic Surgery				
Chirurgia naczyniowa i torakochirurgia	120 - 128			
Bone Punches, Rongeurs				
Przebijaki kostne i odgryzacze	129 - 134			
Elevators, Bone Levers, Raspatories, Bone Files, Bone Curettes				
Podważki, dźwignie, skrobaczki, pilniki, łyżeczki kostne	135 - 139			
Mallets, Chisels and Gouges				
Młotki, dłuta, dłuta wklęsłe	140 - 141			
Bone Holding Forceps, Bone Rongeurs, Bone Cutting Forceps				
Kleszcze do kości, kleszcze tnące	142 - 146			
Plaster Instruments				
Narzędzia do gipsu	147 - 157			

Percussion Hammers and Aesthesiometers



Stethoscopes



01-110
PINARD (Aluminum)
Size: 155 mm

1/2



01-111
wooden
Size: 145 mm

1/2



01-112
BOWLES
Stethoscope
with diaphragm

1/4



01-113
ANESTOPHON

1/2



01-114
FORD-BOWLES
Dual chest piece
with two outlets

1/4



01-115
BOWLES

1/4

Head Mirrors and Head Bands



01-116
ZIEGLER \varnothing 90mm
head mirror only
with rubber coating



01-117
ZIEGLER \varnothing 90mm
head mirror only
with metal coating



01-118
ZIEGLER
head band of plastic black



01-120
MURPHY
head band of celluloid, white

01-119
ZIEGLER
head band of plastic white



01-121
head band of plastic,
white, soft pattern



01-122
head mirror with black
plastic head band.

Tongue Depressors

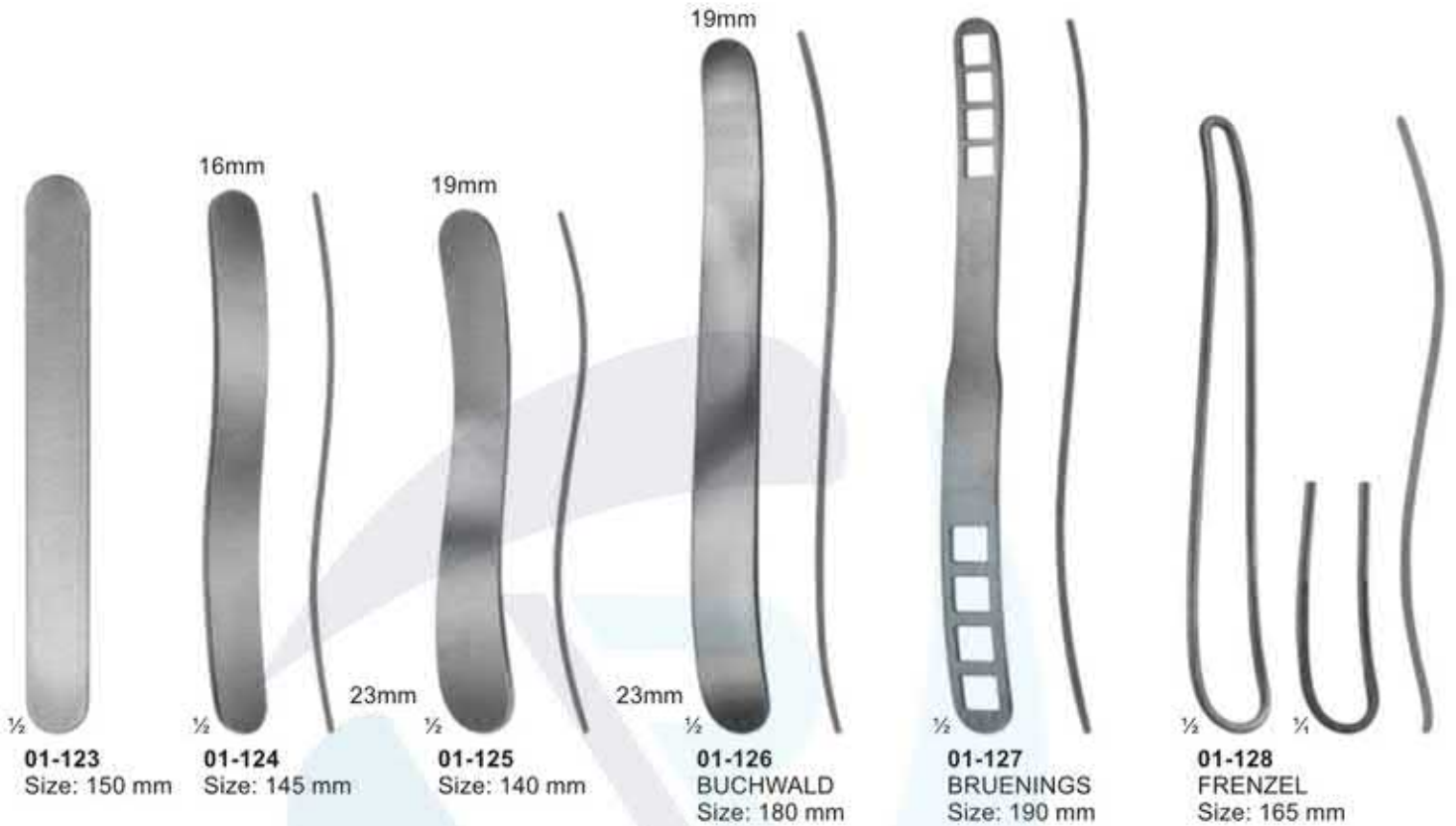

Instruments for Anaesthesia and Tongue Forceps



1/2
01-134
SCHIMMELBUSCH
Ether mask



1/2
01-135
HEISTER
Mouth gag
Size: 130 mm



1/2
01-136
FERGUSSON-ACKLAND
Mouth gag
Size: 145 mm



1/2
01-137
DENHARDT
Mouth gag with silicon
inserts, interchangeable
Size: 125 mm



1/2
01-138
ROSER KOENIG
Mouth gag
Size: 160 mm, 185 mm



1/2
01-139
YOUNG
Size: 165 mm



1/4
1 Pair Of
Rubber Pads



1/2
01-140
COLLIN
Size: 160 mm,
170 mm



1/4
Size: 160 mm



1/4
Size: 170 mm



1/2
01-141
HEYWOOD-SMITH
modif. Size: 215 mm

Blood Lancets and Laryngeal Mirrors

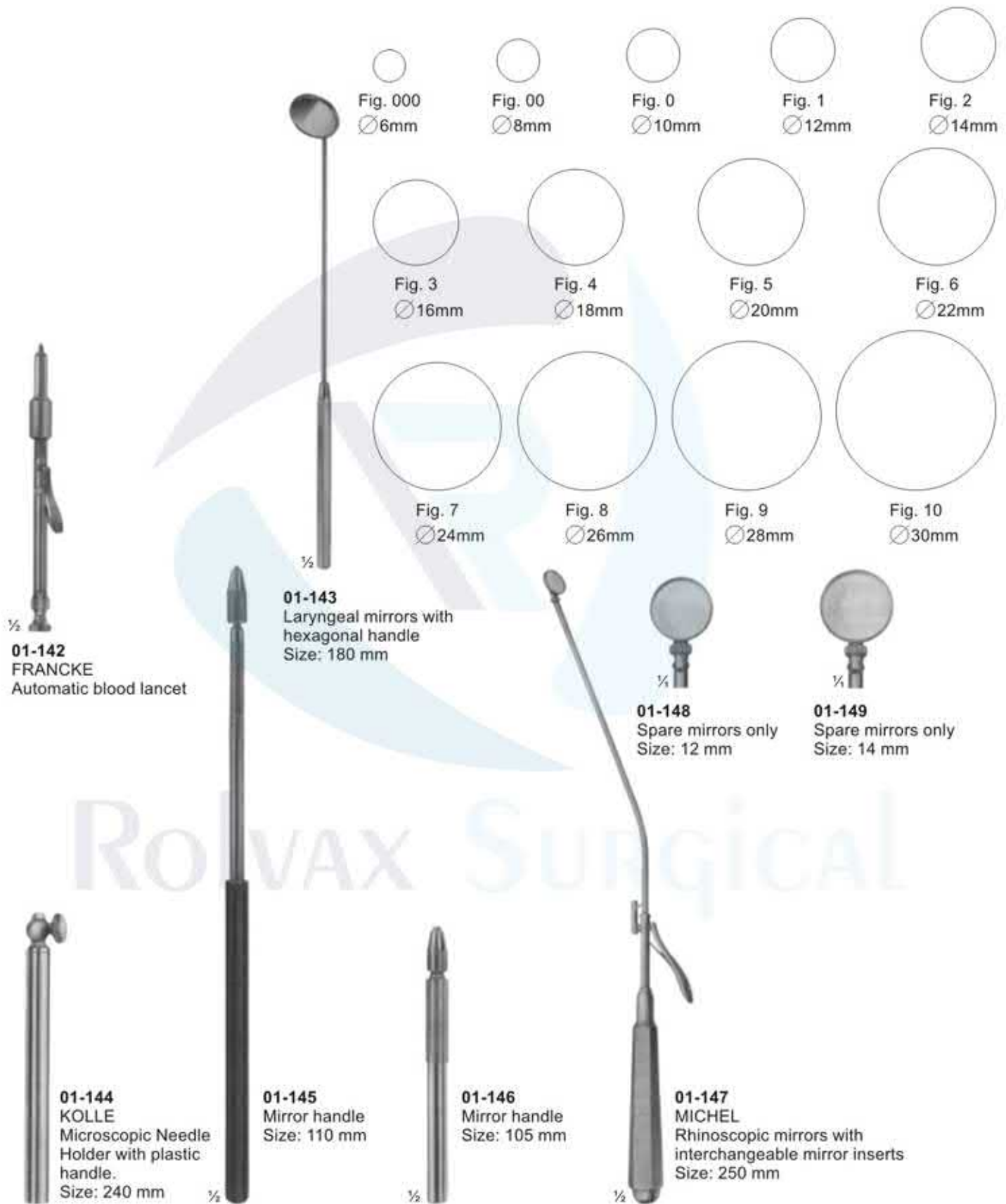

Diagnostic Sets



01-156
ENT Set
Otoscope, consists of
battery handle without batteries,
3 ear specula, 1 bulb in valvet lined case



01-157
Otoscope Set with three specula.

Laryngoscopes



01-158
MILLER
 Laryngoscope set, consists of battery handle (without battery)
 with five miller laryngoscope blades

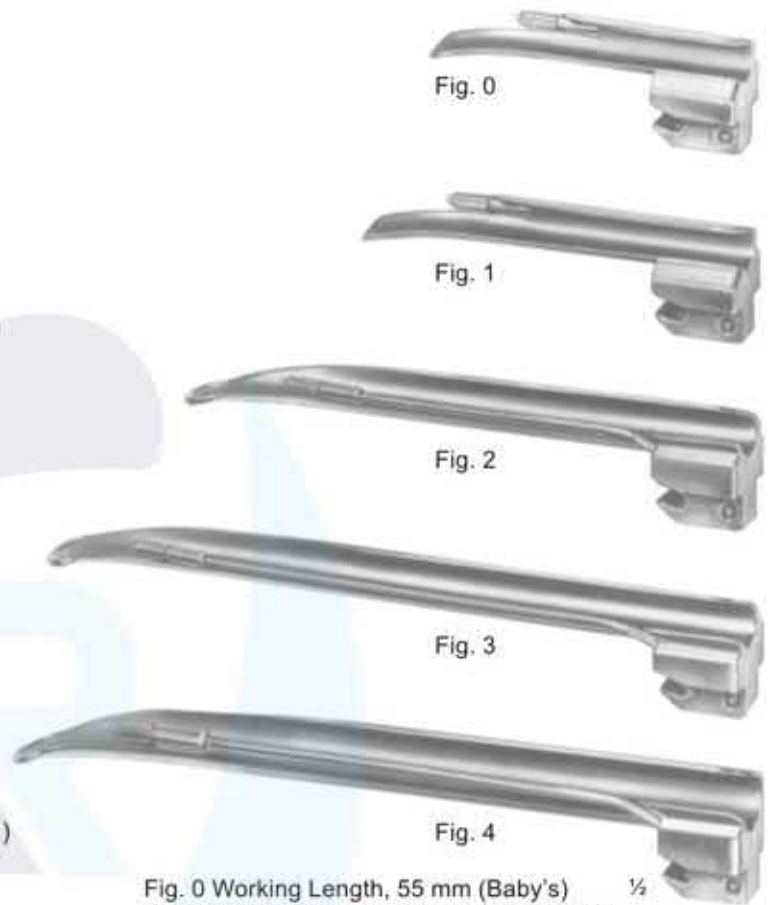

Fig. 0 Working Length, 55 mm (Baby's)
 Fig. 1 Working Length, 80 mm (Children's)
 Fig. 2 Working Length, 130 mm (Adolescent's)
 Fig. 3 Working Length, 170 mm (Women's)
 Fig. 4 Working Length, 180 mm (Men's)



01-159
GUEDEL-NEGUS
 Laryngoscope set, consists of battery handle (without battery)
 with four miller laryngoscope blades



Fig. 1 Working Length, 70 mm (Children's)
 Fig. 2 Working Length, 90 mm (Adolescent's)
 Fig. 3 Working Length, 110 mm (Women's)
 Fig. 4 Working Length, 135 mm (Men's)

Laryngoscopes



01-160
McINTOSH
Laryngoscope Set, Consists Of Battery Handle (Without Battery)
With Three McIntosh Blades, Fig. 1, Fig. 2, Fig. 3

01-161
McINTOSH
Laryngoscope Set, Consists Of Battery Handle (Without Battery)
With Five McIntosh Blades, Fig. 0, Fig. 1, Fig. 2, Fig. 3, Fig. 4



01-162
FOREGGER
Laryngoscope Set, Consists Of Battery Handle (Without Battery)
With Three Foregger Blades,
Fig. 1, Fig. 2, Fig. 3,

01-163
FOREGGER
Laryngoscope Set, Consists Of Battery Handle (Without Battery)
With Four Foregger Blades,
Fig. 1, Fig. 2, Fig. 3, Fig. 4,

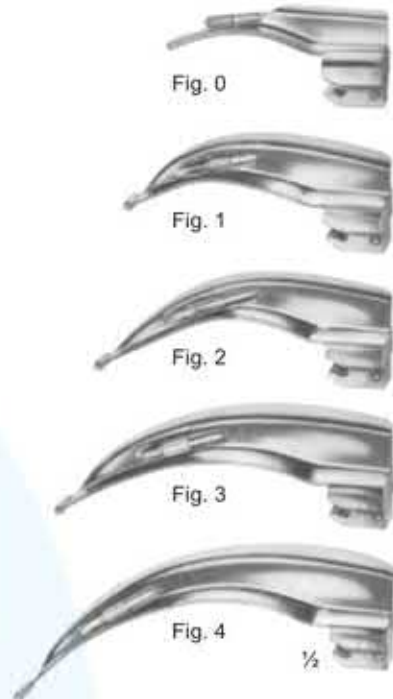

01-161 A Fig. 0 Working Length, 55 mm (Baby's)
01-161 B Fig. 1 Working Length, 75 mm (Children's)
01-161 C Fig. 2 Working Length, 90 mm (Adolescent's)
01-161 D Fig. 3 Working Length, 110 mm (Women's)
01-161 E Fig. 4 Working Length, 135 mm (Men's)

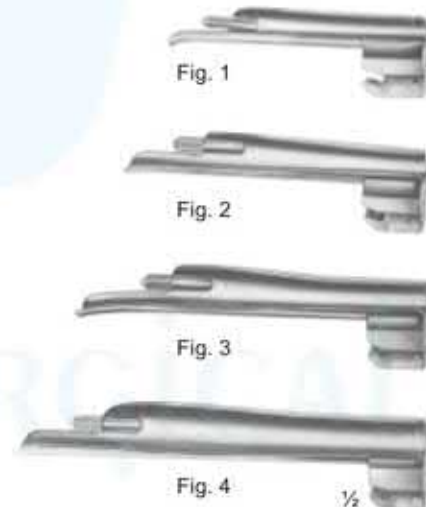

01-162 A Fig. 1 Working Length, 70 mm (Children's)
01-162 B Fig. 2 Working Length, 90 mm (Adolescent's)
01-162 C Fig. 3 Working Length, 110 mm (Women's)
01-162 D Fig. 4 Working Length, 135 mm (Men's)



01-164
Fiber Optic
Battery Handle
30mm diam.



01-165
Fiber Optic
Battery Handle
18mm diam.



01-166
Replacement Lamp
(Krypton) 2.5 V



01-167
Replacement Lamp
(Halogen) 2.5 V

Examination & Measuring Instruments



01-168
Caliper Of Aluminium
Graduated in mm & inches
up to 180mm
Measuring Range up to 139mm



01-169
VERNIER
Universal Caliper Of Steel
Graduated in mm & inches
up to 180mm
Measuring Range up to 120mm
with Vernier in 1/10mm & 1/16"



01-170
CARROLL
Size: 145 mm
Finger Goniometer



01-171
TOWNLEY
Graduated in
mm & inches
Size: 115 mm



01-172
COLLIN
Druck Pressure 72 kg
Size: 125 mm



01-173
BERTILLON
Caliper For Measuring The Head
Size: 320 mm



01-174
CASTROVIEJO
Caliper
Size: 75mm



01-175
MOLTGEN
Goniometer



01-176
Size: 150 mm



01-177
Size: 500 mm

Dissecting Knives



02-101 - 110
Fig. 1 - 10



02-101
Fig. 1
30 mm



02-102
Fig. 2
36 mm



02-103
Fig. 3
40 mm



02-104
Fig. 4
45 mm



02-105
Fig. 5
50 mm



02-106
Fig. 6
27 mm



02-107
Fig. 7
35 mm



02-108
Fig. 8
40 mm



02-109
Fig. 9
47 mm



02-110
Fig. 10
50 mm

Amputating Knives, Cartilage Knives and Autopsy Knives



LISTON
02-111
Size: 130 mm
02-112
Size: 160 mm
02-113
Size: 190 mm
02-114
Size: 200 mm

02-115
CATLIN
Size: 160 mm
Blade length
Amputating
Knives

02-116
LANGENBECK
Size: 120 mm
Blade length
Flap Knives

02-117
Size: 110 mm
Blade length
Interosseous
Knives

02-118
Size: 55 mm
Blade length
with raspatory,
Wooden handle

02-119
Size: 70 mm
Blade length
Wooden handle

02-120
Size: 80 mm
Blade length
Metal handle

02-121
Size: 195 mm
Blade length
Metal handle

Blade length
Amputating Knives

Cone Knives, Myomatome, Trigeminal and Tonsil Knives



1/4

02-122
 AYRE
 Size: 235 mm
 Cone Knife

1/4

02-123
 Size: 230 mm
 Cone Knife

1/4

02-124
 SEGOND
 Size: 270 mm
 Myomatome

1/2

02-125
 OLIVECRONA
 Size: 205 mm
 Trigeminal
 Knife

1/4

02-126
 Size: 230 mm
 Trigeminal
 Knife

1/4

02-127
 FOWLER
 Size: 200 mm
 Tonsil Knife

1/4

02-128
 ABRAHAM
 Size: 215 mm
 Tonsil Knife

1/4

02-129
 BRUNINGS
 Size: 215 mm
 Tonsil Knife

Scalpel Handles



<p>02-130 STANDARD No. 3 No. 3 Solid 12 cm</p>	<p>02-131 No. 3 Solid 12 cm</p>	<p>02-132 No. 3 Solid 12 cm</p>	<p>02-133 No. 3 L Straight Solid 21.5 cm</p>	<p>02-134 No. 3 L Angled Solid 21 cm</p>	<p>02-135 No. 7 Solid 16 cm</p>	<p>02-136 No. 7 K Solid 12.5 cm</p>	<p>02-137 Hollow-Round 15.5 cm</p>	<p>02-138 No. 3 Straight Solid, Round 14.5 cm</p>	<p>02-139 No. 3 Angled Solid, Round 14 cm</p>
--	---	---	--	--	---	---	--	---	---

Micro Scissors (Spring Type) with Flat Handles

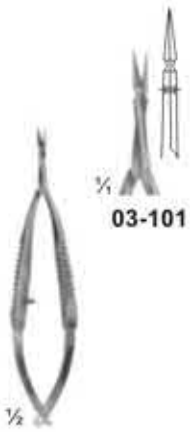

03-101 - 103
VANNAS
Size: 85 mm



03-101



03-102



03-103



03-104 - 105
CASTROVIEJO
Size: 95 mm



03-104



03-105



03-106
NOYES
Size: 125 mm



1/4



03-107 - 108
WECKER
Eye scissor
Size: 110 mm



03-107



03-108



03-109
CASTROVIEJO
Eye scissor
Size: 115 mm



1/4



03-110 - 111
CASTROVIEJO
Eye scissor
Size: 110 mm



03-110



03-111

Micro Scissors (Spring Type) with Flat Handles

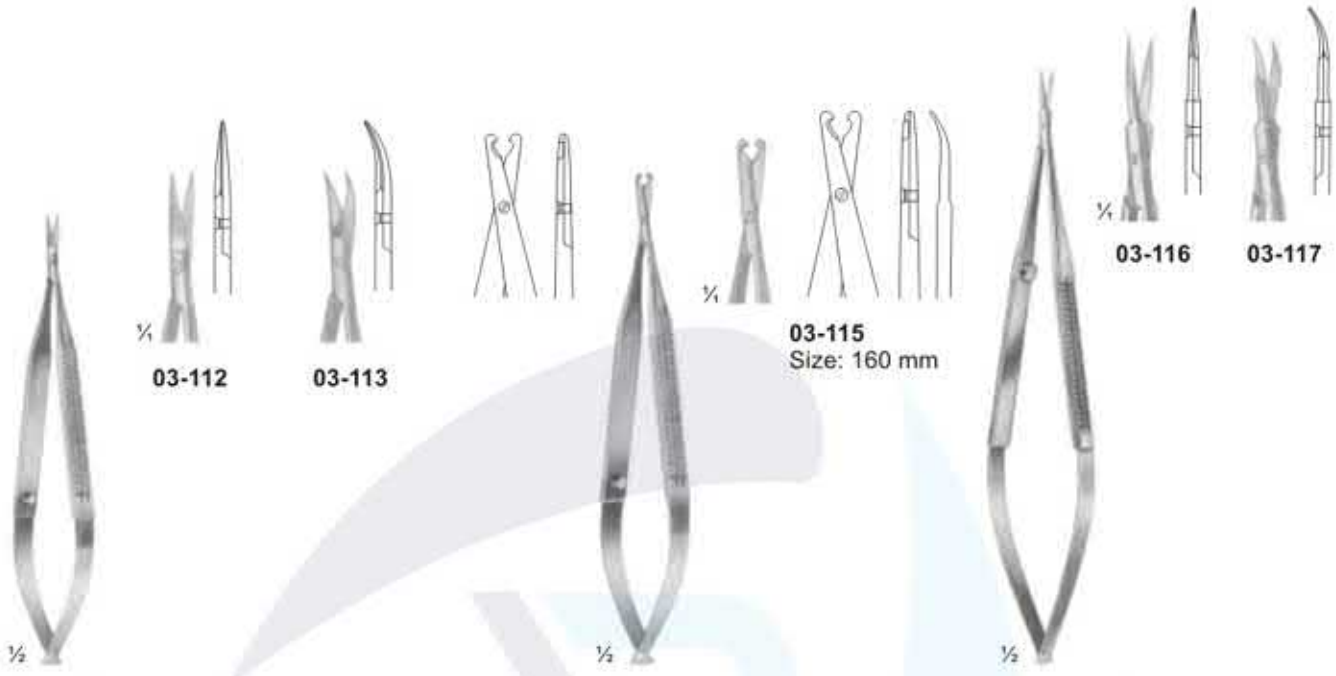

03-112 - 113
Size: 120 mm

03-114
BIEMER
Vein scissor
Size: 130 mm

03-116 - 117
VANNAS
Size: 160 mm

03-115
Size: 160 mm



03-118
CASPAR
Micro scissor curved
Size: 115 mm

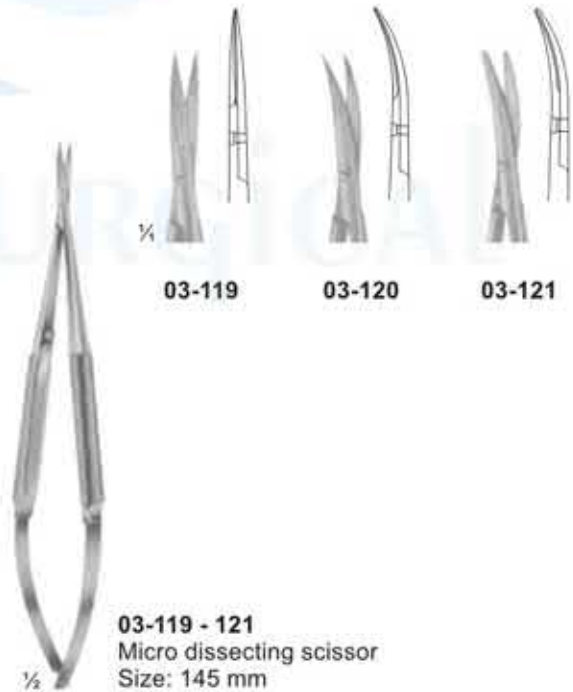

03-119

03-120

03-121

03-119 - 121
Micro dissecting scissor
Size: 145 mm

Micro Scissors (Spring Type) bayonet-Shaped



03-122
YASARGIL
Size: 245 mm



03-123
45°



03-124
45°



03-123 - 124
laterally angled
Size: 200 mm



125°



03-125
laterally angled
Size: 190 mm



03-126



03-127



03-126 - 127
YASARGIL
Size: 225 mm

Delicate Scissors

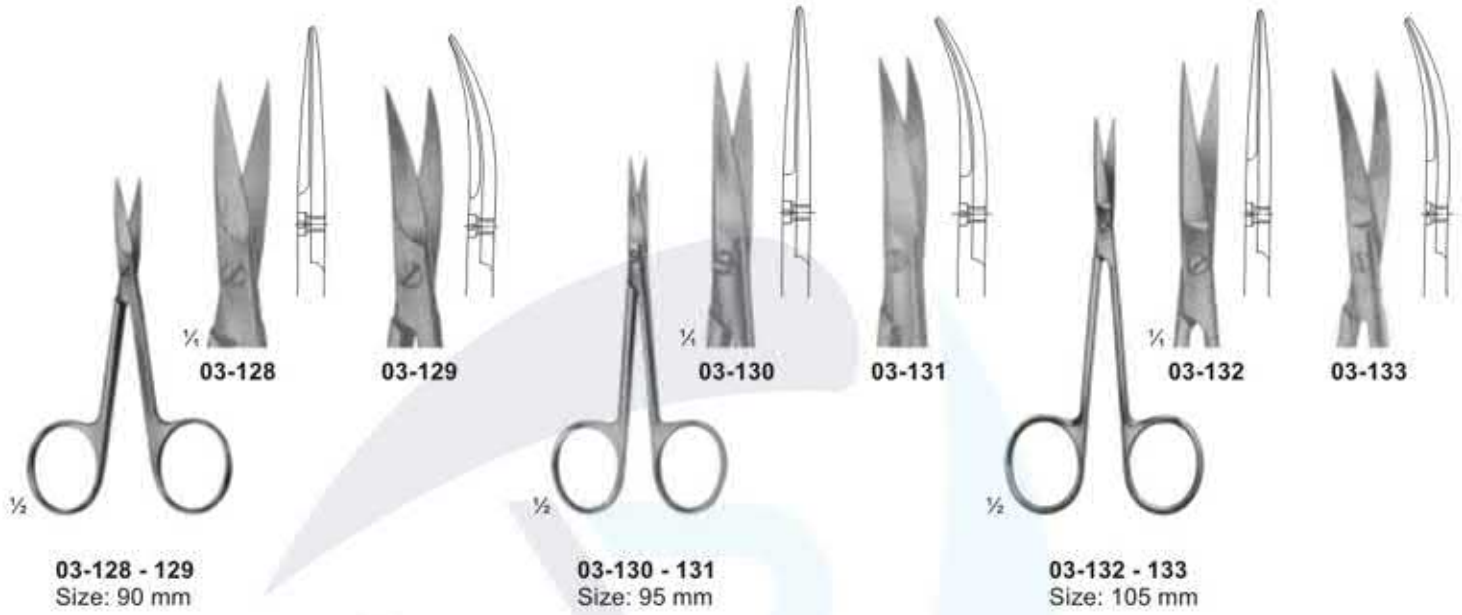

Delicate Scissors



03-138 - 140
Size: 120 mm



03-138

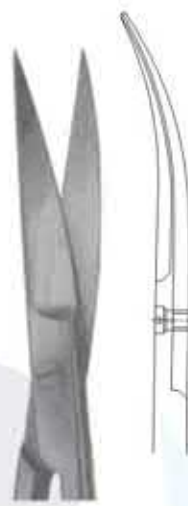

03-139



03-140



03-141 - 144
Size: 130 mm



03-141



03-142



03-143



03-144

Surgical Scissors

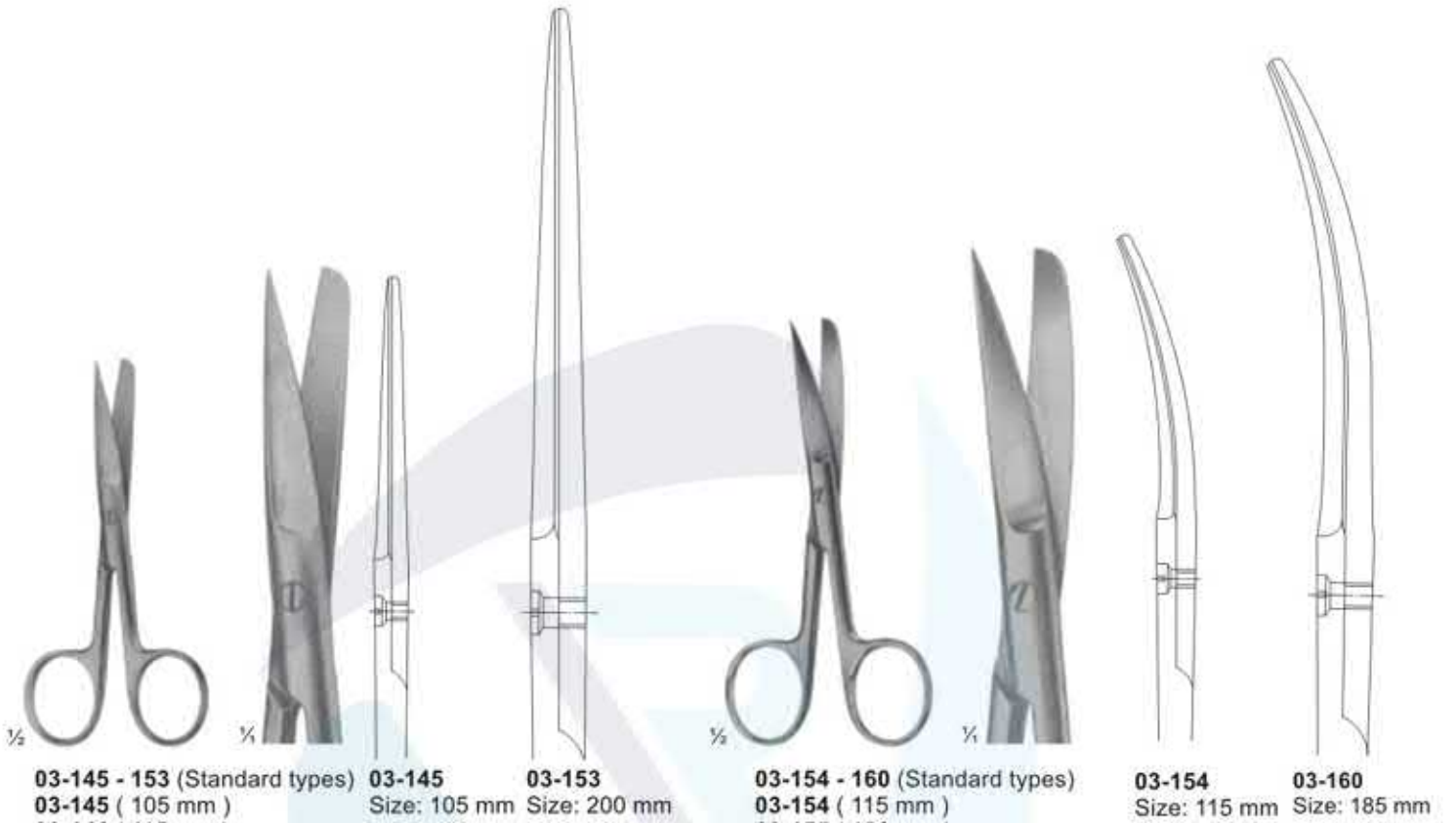

- 03-145 - 153 (Standard types)**
 03-145 (105 mm)
 03-146 (115 mm)
 03-147 (130 mm)
 03-148 (145 mm)
 03-149 (150 mm)
 03-150 (165 mm)
 03-151 (175 mm)
 03-152 (185 mm)
 03-153 (200 mm)

- 03-145** **03-153**
 Size: 105 mm Size: 200 mm

- 03-154 - 160 (Standard types)**
 03-154 (115 mm)
 03-155 (130 mm)
 03-156 (145 mm)
 03-157 (150 mm)
 03-158 (165 mm)
 03-159 (175 mm)
 03-160 (185 mm)

- 03-154** **03-160**
 Size: 115 mm Size: 185 mm



- 03-161** **03-162**
 130 mm 145 mm

- 03-163** **03-164**
 130 mm 145 mm

- 03-165**
 130 mm

- 03-166**
 130 mm

03-161 - 164
 Slender types

03-165 - 166
 for wound edges. 1 blade serrated

Surgical Scissors



03-167 - 169
DEAVER
with flat lock

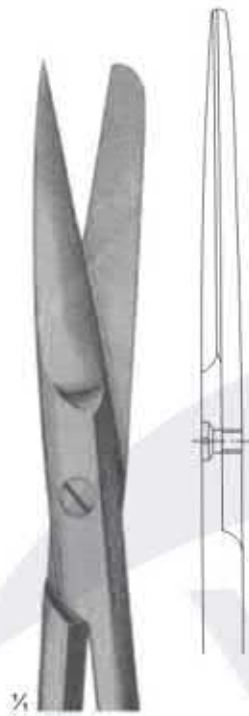

03-167
Size: 145 mm

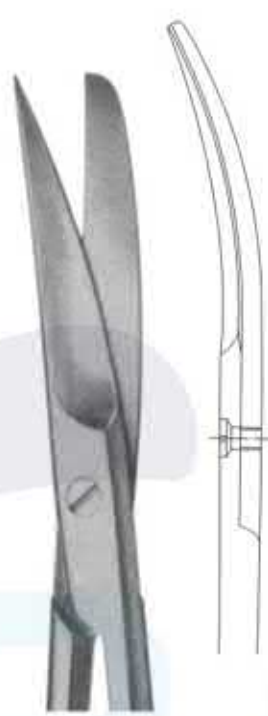

03-168
Size: 145 mm

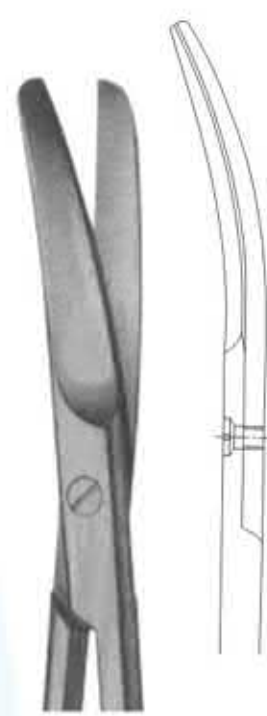

03-169
Size: 145 mm



03-170 - 172
Incision scissors



03-170
Size: 130 mm



03-171
Size: 145 mm



03-172
Size: 165 mm



03-173
SYSTRUNK
Nail splitting scissors

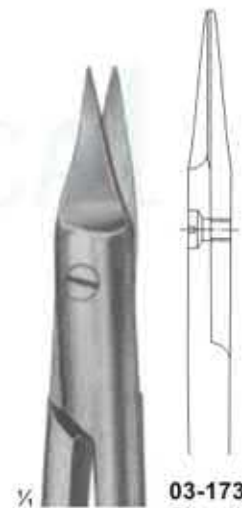

03-173
Size: 130 mm

Dissecting Scissors

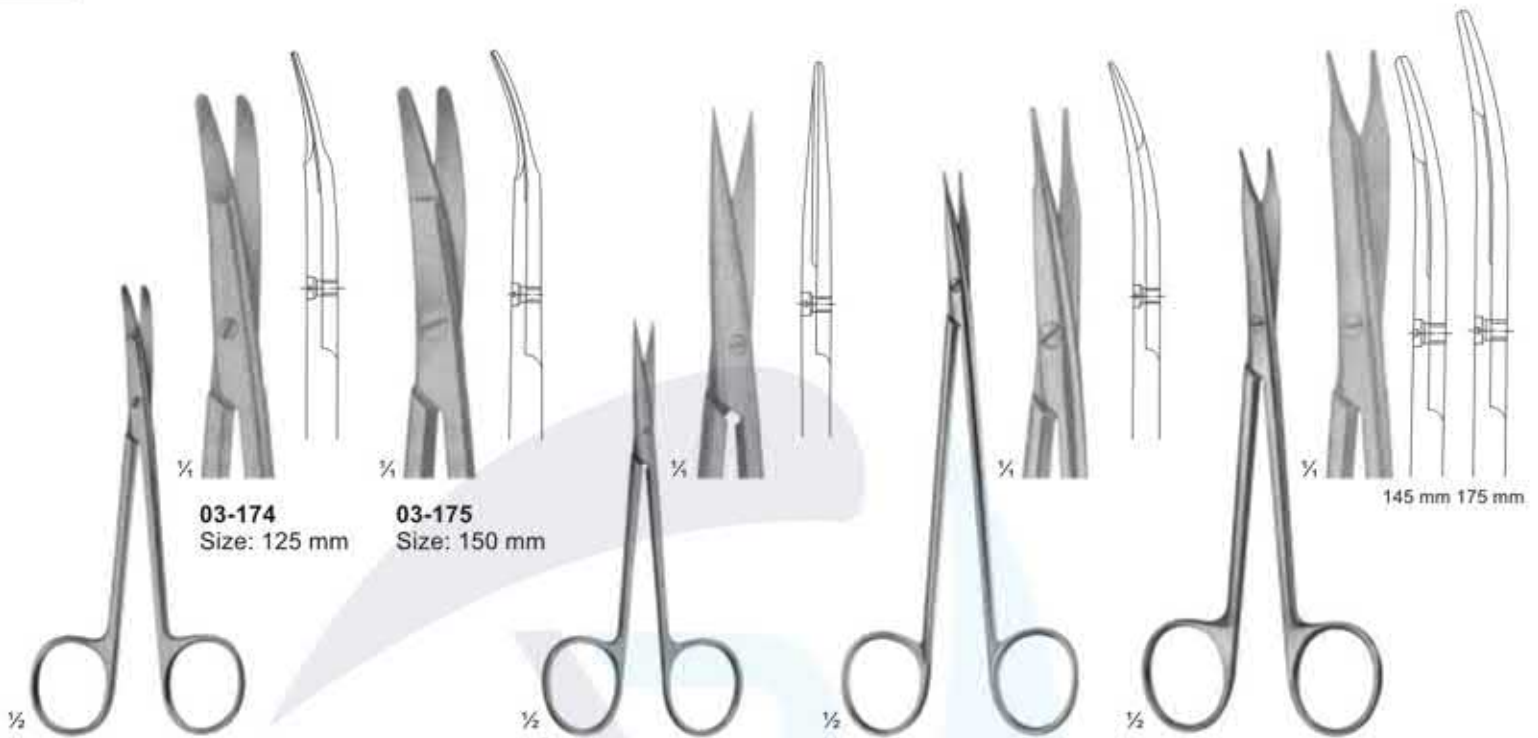

03-174 - 175
KILNER
 Special flat points for dissecting and undermining the skin

03-176
KILNER
 Fine dissecting scissors
 Size: 115 mm

03-177
JAMESON
 Dissecting scissors
 Size: 150 mm

03-178
REYNOLDS
 Dissecting scissors
 Size: 145 - 175 mm

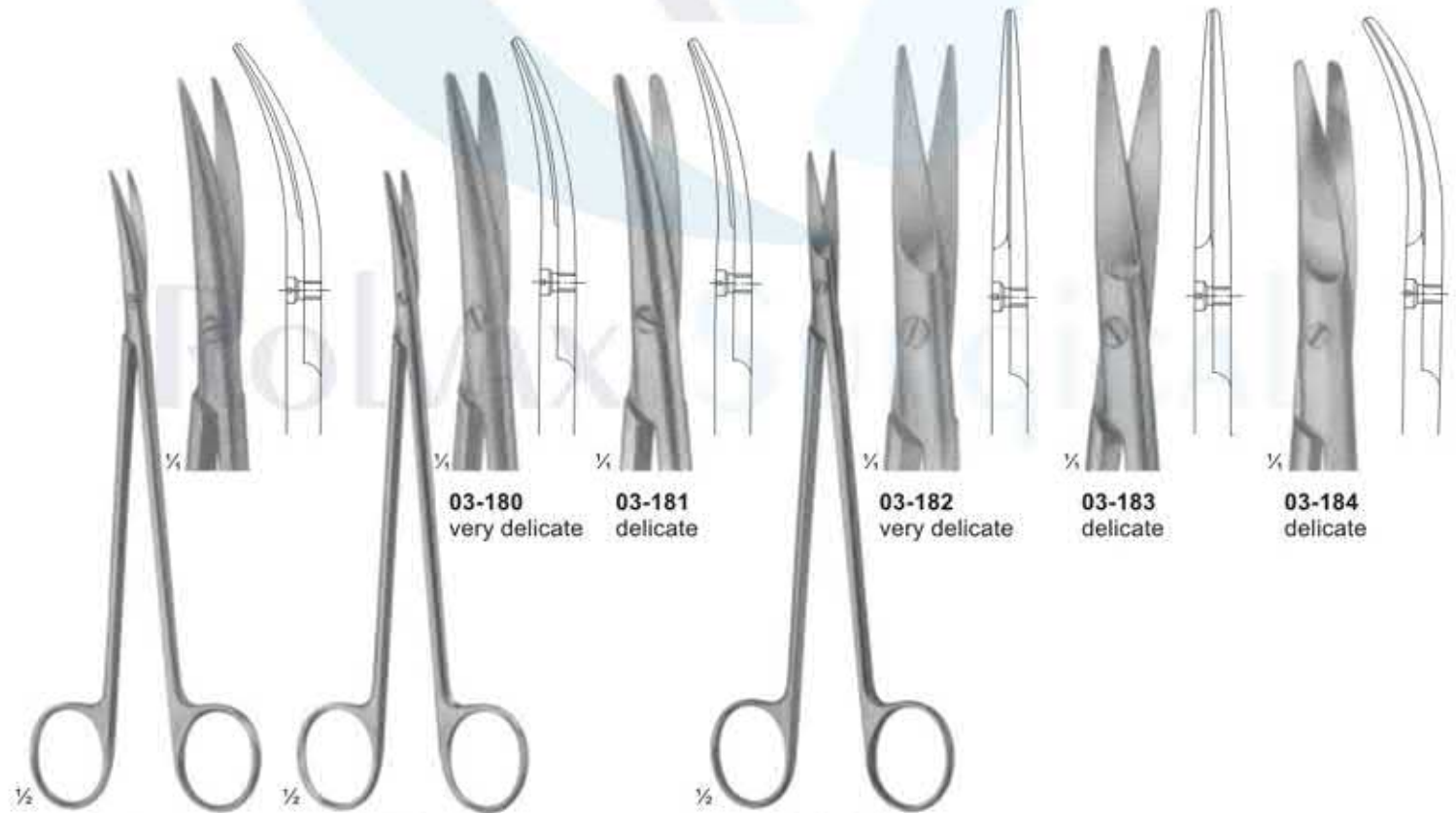

03-179
DE BAKEY
 Arteriotomy scissors
 Size: 175 mm

03-180 - 181
TOENNIS ADSON
 Dissecting scissors
 Size: 175 mm

03-182 - 184
TOENNIS
 Dissecting scissors
 Size: 180 mm

Dissecting Scissors



Scissors for Cardiovascular and Neuro-Surgery



03-197
OLIVECRONA
Dura scissors



03-198
STRULLY
pointed
Size: 220 mm

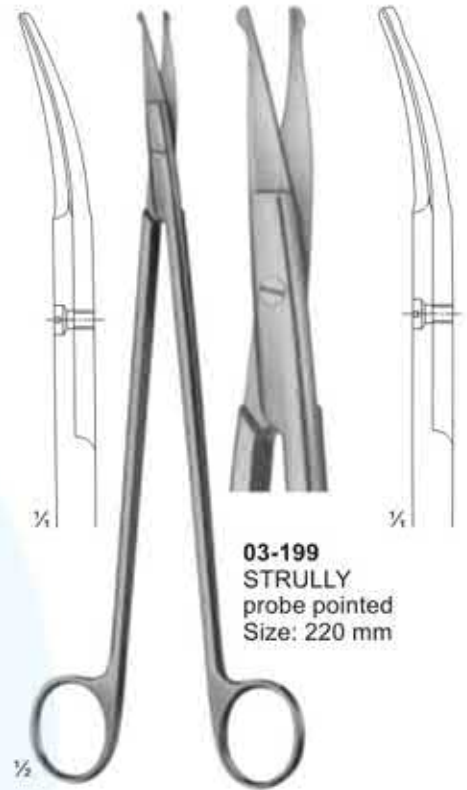

03-199
STRULLY
probe pointed
Size: 220 mm



03-200
THOREK
Size: 180 mm



03-201
POTTS-SMITH
Size: 190 mm



03-202
SATINSKY
Size: 245 mm

Delicate, Nasal and Tonsil Scissors



03-203
1 finely toothed blade
Size: 130 mm

03-204
LOCKLIN
curved sideways,
1 toothed blade
Size: 155 mm

03-205
FOMON
blades serrated
Size: 145 mm

03-206
COTTLE
Size: 165 mm



03-207
HEYMANN-KNIGHT
Size: 175 mm

03-208
DEAN
blades serrated
Size: 170 mm

03-209
GOOD
Size: 195 mm

Bone Shears



03-210
KILLIAN
Size: 200 mm



03-211 - 03-212



03-211
195 mm



1/2



03-212
225 mm



1/2

Scissors for deep operations and for Gynaecology



Scissors for Obstetrics



03-222
SCHUMACHER
 Umbilical cord scissors
 Size: 155 mm

03-223
 Umbilical cord scissors
 Size: 105 mm

03-224
 Umbilical cord scissors
 135 mm



03-225 - 03-226
BRAUN-STADLER
 Episiotomy scissors

03-226
 200 mm

03-227
 Episiotomy scissors
 240 mm

Wire and Plate Scissors

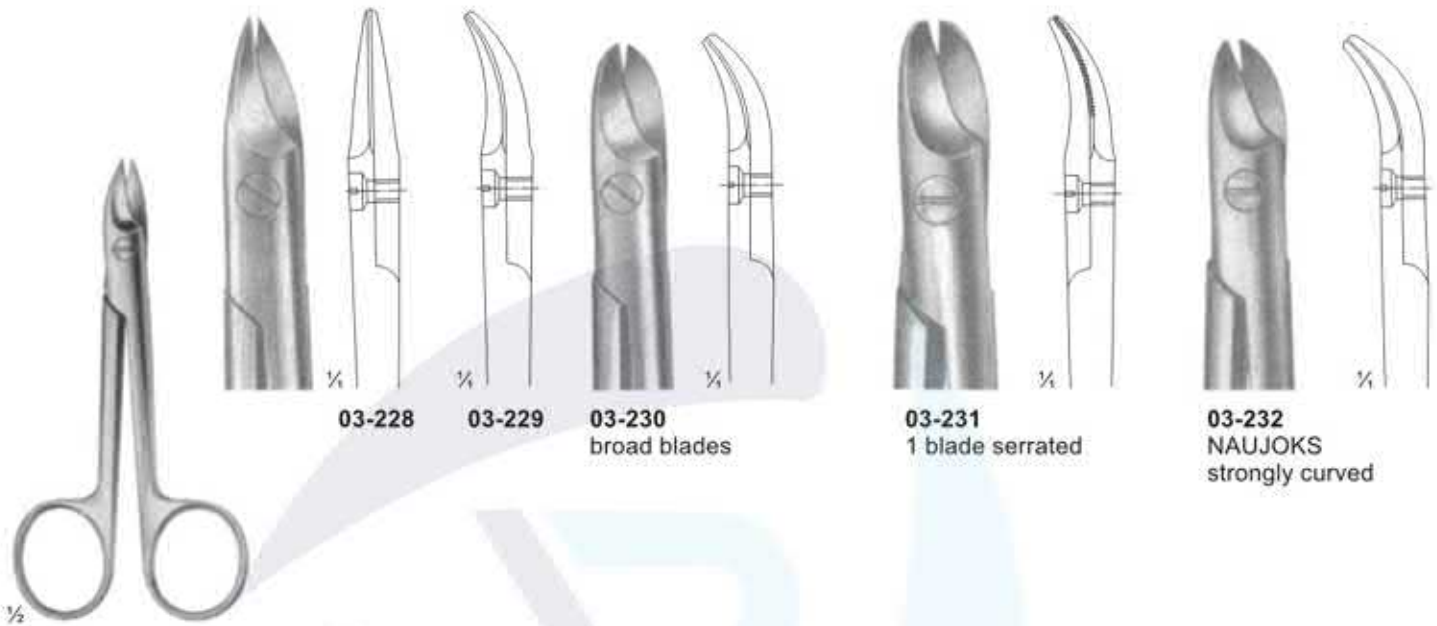

03-228

03-229

03-230
broad blades

03-231
1 blade serrated

03-232
NAUJOKS
strongly curved

03-228 - 03-232
BEEBE
Size: 110 mm



03-233
1 blade serrated
Size: 120 mm

03-234
STRACK
Size: 100 mm

03-235
HARVEY
blades serrated
Size: 125 mm

Bandage and Cloth Scissors



03-236
Universal bandage and cloth scissors,
with toothed edges
180 mm

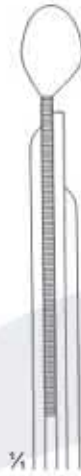

03-237
LISTER
Universal bandage and cloth scissors,
with toothed edges
Size: 145 mm

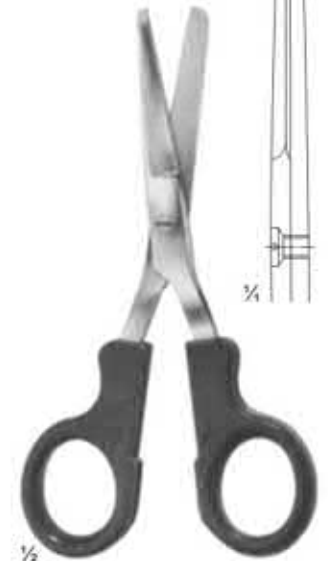

03-238
LISTER
Nurse's scissors
Size: 145 mm



03-239 - 03-242
LISTER



03-239
115 mm

03-240
140 mm

03-241
180 mm

03-242
200 mm



03-243 - 03-244
LISTER



03-243
155 mm

03-244
180 mm

Bandage-, Cloth-, and Plaster Scissors

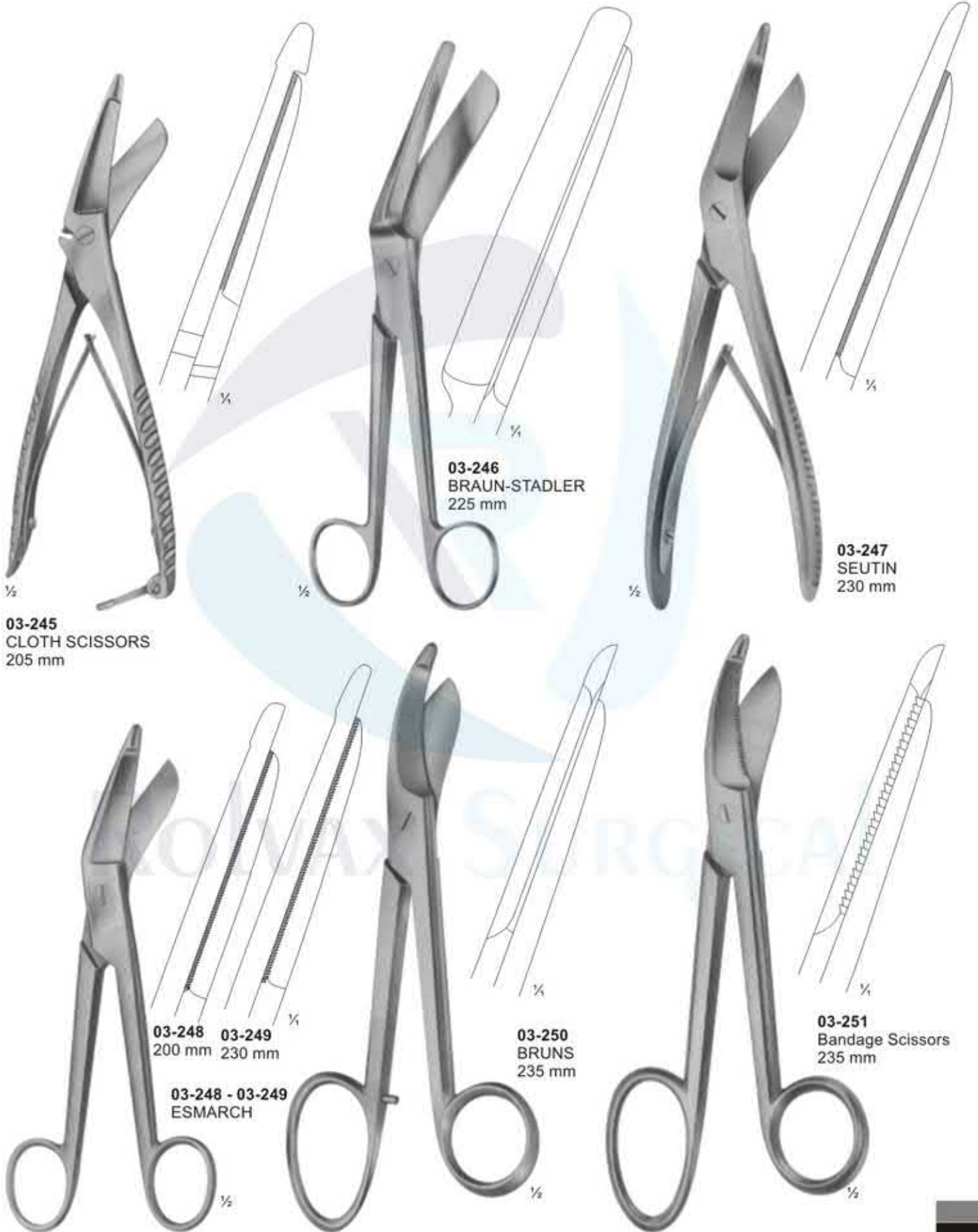

03-245
CLOTH SCISSORS
205 mm

03-246
BRAUN-STADLER
225 mm

03-247
SEUTIN
230 mm

03-248 200 mm
03-249 230 mm

03-248 - 03-249
ESMARCH

03-250
BRUNS
235 mm

03-251
Bandage Scissors
235 mm

Forceps for grasping tissue, tumors etc.



04-101 - 103
YASARGIL-SAMII
Jaws spoon-shaped
240 mm

04-104 - 105
YASARGIL
Jaws spoon-shaped
220 mm

04-106 - 108
SAMII
Jaws spoon-shaped
230 mm

04-109 - 111
SAMII
Jaws spoon-shaped
230 mm



04-112
HUNT
Tumor-and
vessel forceps
200 mm



04-113
HUNT
Tumor-and
vessel forceps
200 mm



04-114
YASARGIL
Tumor-and
vessel forceps
200 mm

Delicate Dissecting, Microscopic, Sterilizing Forceps



04-115
THORPE
Corneal forceps
120 mm



04-116
MICRO-ADSON
120 mm



04-117
ADSON
120 mm



04-118
MICRO-ADSON
150 mm



04-119 - 121
100 mm



04-119



04-120



04-121

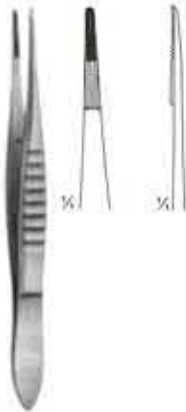

04-122
BONACCOLTO
110 mm



04-123
115 mm



04-124 - 133



04-124
90 mm



04-125
105 mm



04-126
115 mm



04-127
130 mm



04-128
145 mm



04-129
90 mm



04-130
105 mm



04-131
115 mm



04-132
130 mm



04-133
145 mm



04-134
100 mm



04-135
100 mm



04-136
100 mm



04-137
KUHNE
Cover glass forceps, 105 mm



04-138
160 mm

Delicate Dissecting Forceps

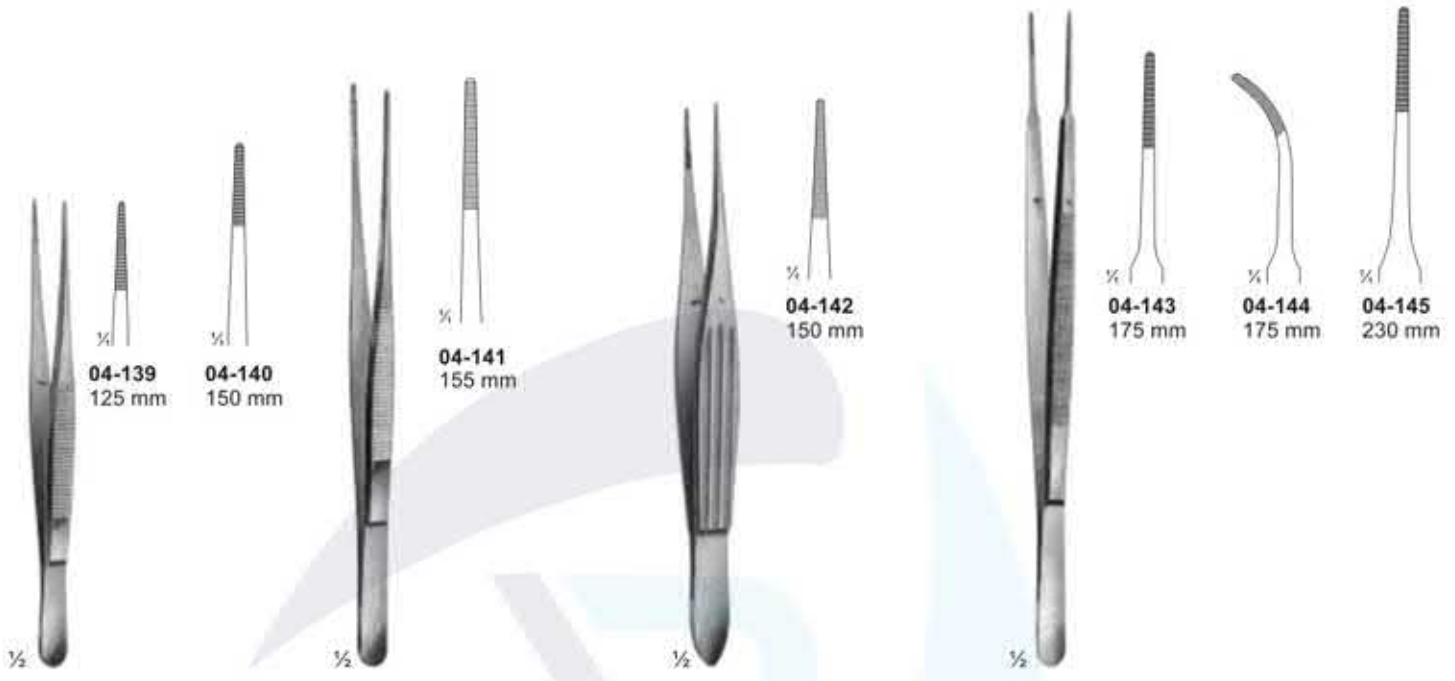

04-139 - 140
SEMKEN

04-141

04-142
MC INDOE

04-143 - 145
GERALD



04-146 - 149
CUSHING

04-150 - 151
BROPHY

04-152 - 153
smooth jaws

04-154

Dissecting Forceps



1/2

04-155 - 04-162
STANDARD

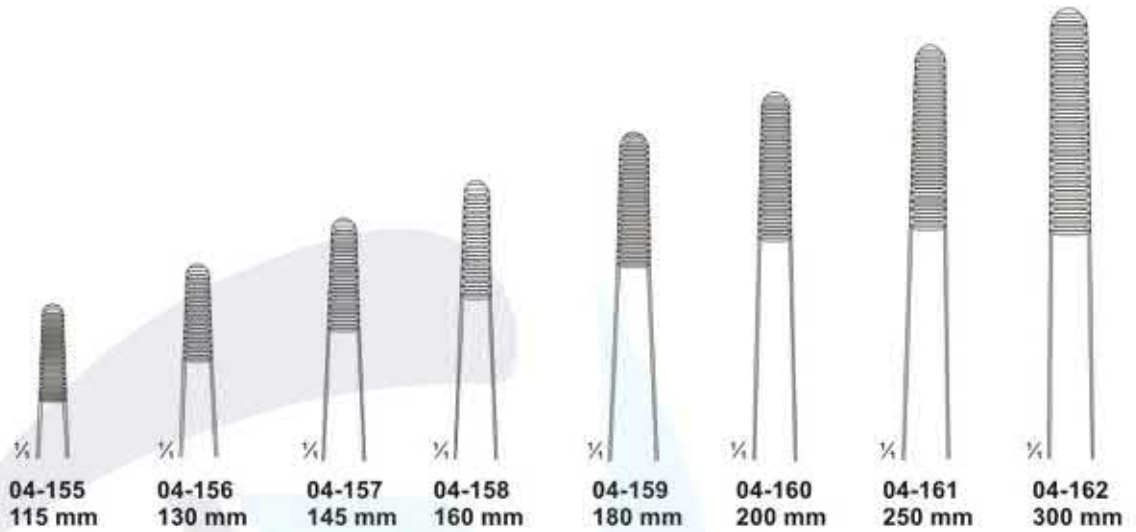

1/2	1/2	1/2	1/2	1/2	1/2	1/2	1/2
04-155	04-156	04-157	04-158	04-159	04-160	04-161	04-162
115 mm	130 mm	145 mm	160 mm	180 mm	200 mm	250 mm	300 mm



1/2

04-163 - 04-167
MEDIUM



1/2	1/2	1/2	1/2	1/2
04-163	04-164	04-165	04-166	04-167
115 mm	130 mm	145 mm	160 mm	305 mm



1/2

04-168 - 04-169
MEDIUM



1/2	1/2
04-168	04-169
130 mm	145 mm

Forceps

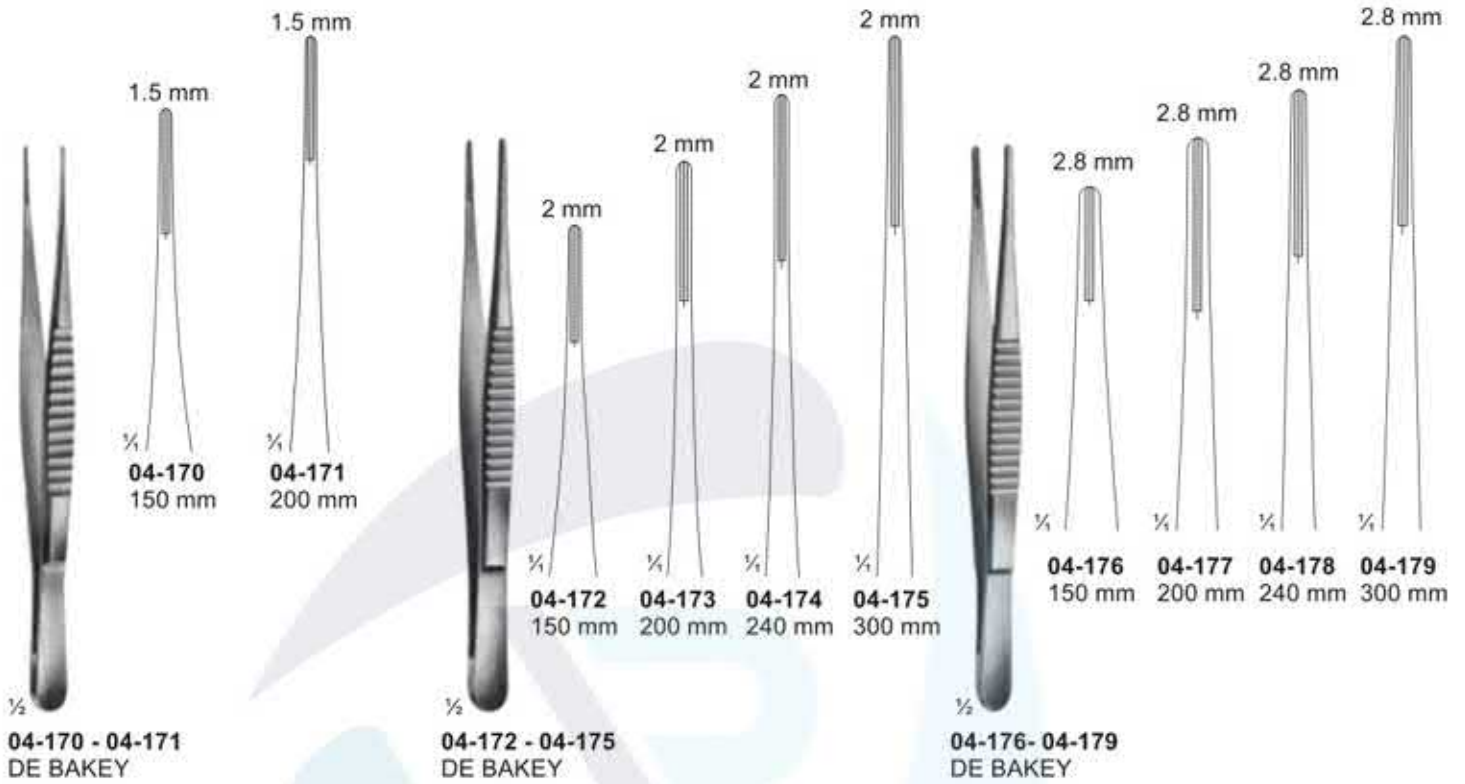

Delicate Tissue Forceps

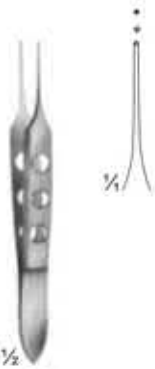

04-185
BISHOP-HARMON
85 mm

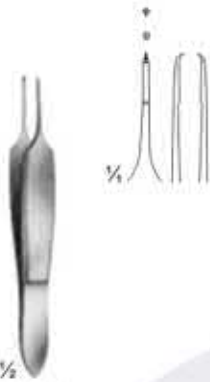

04-186
ST.MARTIN
80 mm

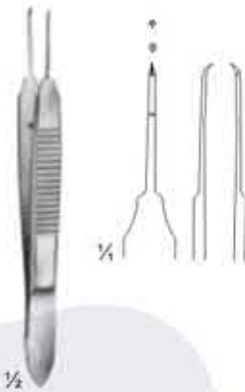

04-187
CASTROVIEJO
teeth 0.9 mm
100 mm

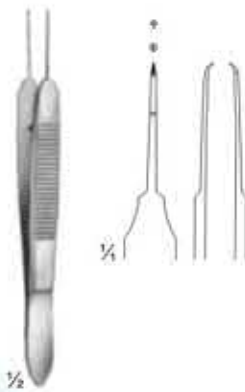

04-188
CASTROVIEJO
teeth 0.5 mm
100 mm

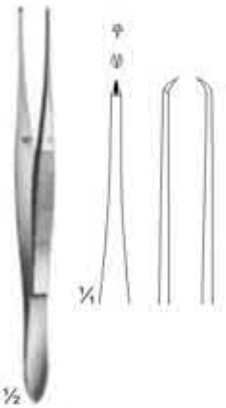

04-189
ELSCHING
110 mm



04-190
GILL
75 mm



04-191
GILL - HESS
75 mm



04-192
HESS
70 mm

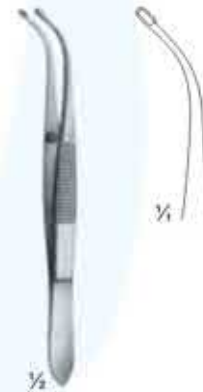

04-193
ARRUGA
100 mm

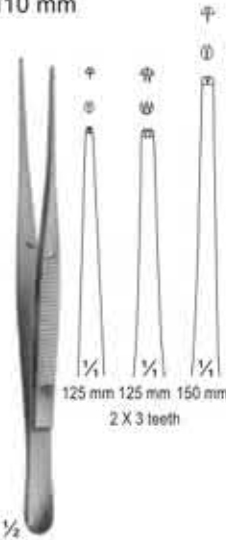

04-194
SEMKEN
125 mm 125 mm 150 mm
2 X 3 teeth

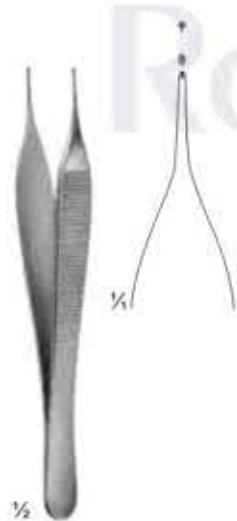

04-195
MICRO-ADSON
120 mm

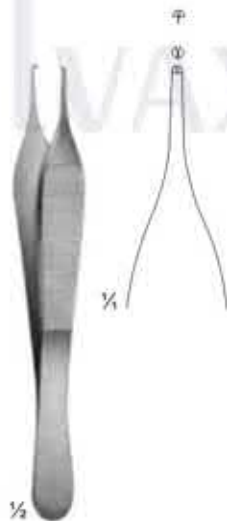

04-196
ADSON
120 mm



04-197
ADSON
120 mm



04-198
ADSON
120 mm

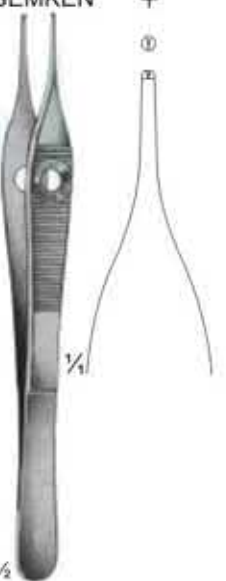

04-199
ADSON
150 mm

Tissue Forceps

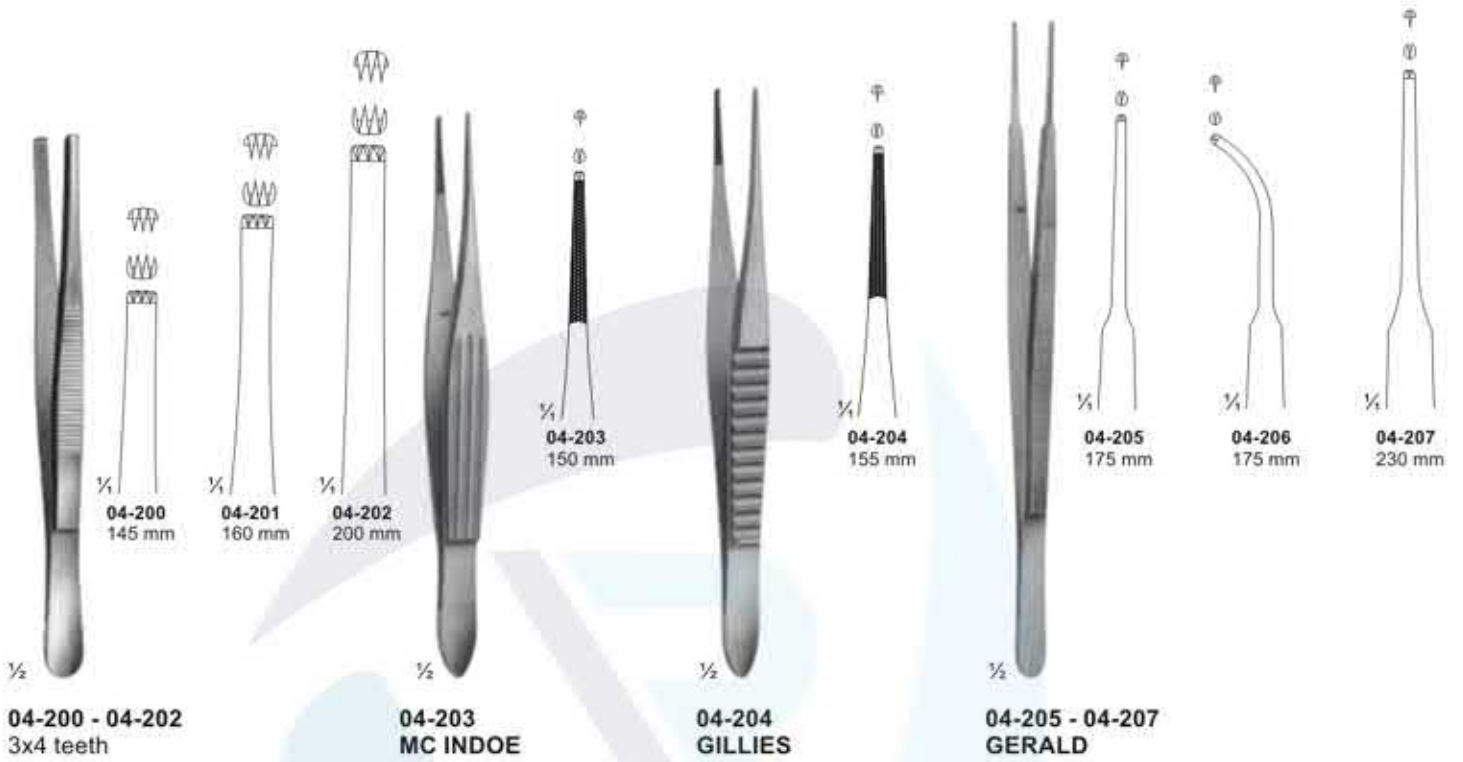

Tissue Forceps



04-213
ADSON - BROWN
 Non-traumatic
 120 mm

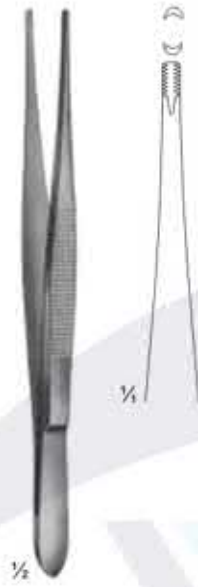

04-214
BROWN
 120 mm



04-215
GRAEFE
 110 mm

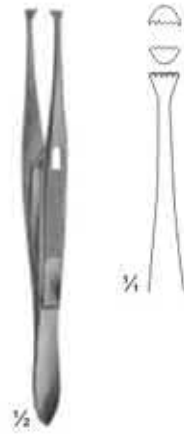

04-216
GRAEFE
 With Catch
 110 mm

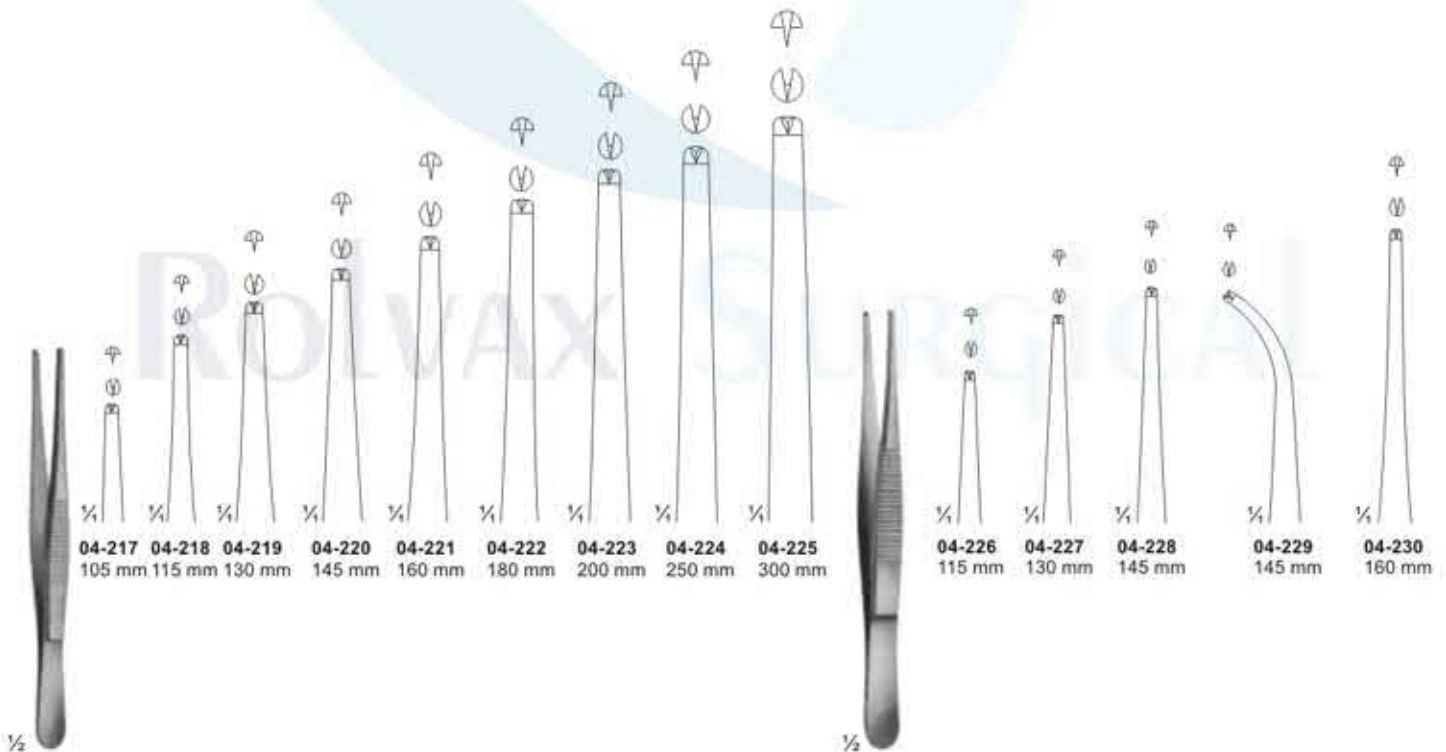

04-217 - 04-225
STANDARD

04-226 - 04-230
GRAEFE
 110 mm

Forceps, Bayonet - Shaped



04-231
LUCAE
140 mm

04-232
LUCAE
1x2 teeth
140 mm

04-233
COTTLE
Forceps with
jaws toothed
and serrated
140 mm

04-234
JANSEN
160 mm

04-235
GRUENWALD
200 mm

04-236
1x2 teeth
200 mm



04-237
TROELTSCH
100 mm

04-238
TROELTSCH
115 mm

04-239
TROELTSCH
1X2 teeth
115 mm

04-240
WILDE
115 mm

04-241
TROELTSCH
Cross action
120 mm

04-242
TROELTSCH
140 mm

Tissue Forceps, Lung Dissecting Forceps



Splinter and Cilia Forceps



Sponge and Dressing Forceps

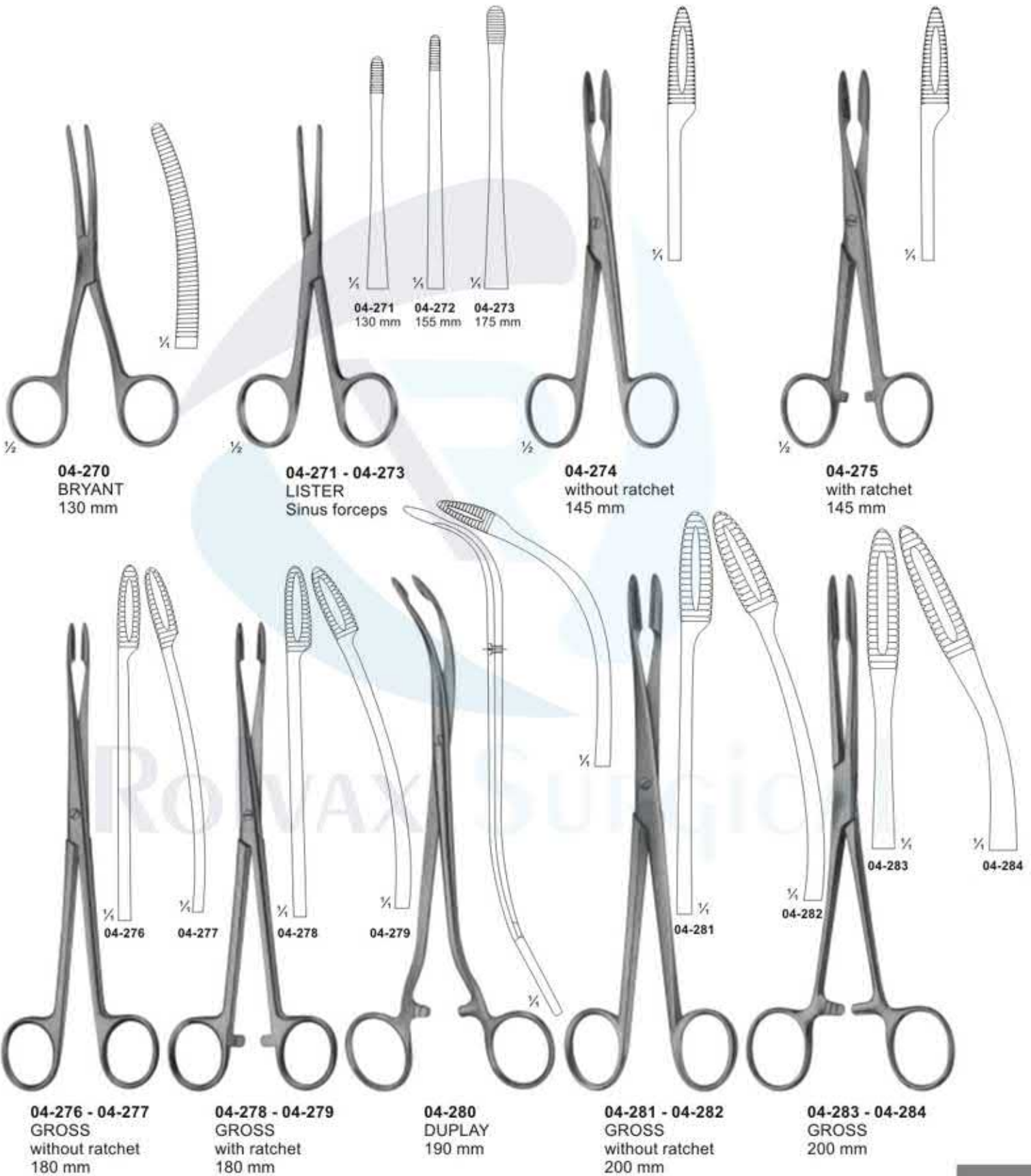

Dressing-, Sponge holding-, Organ- and Tissue Grasping Forceps

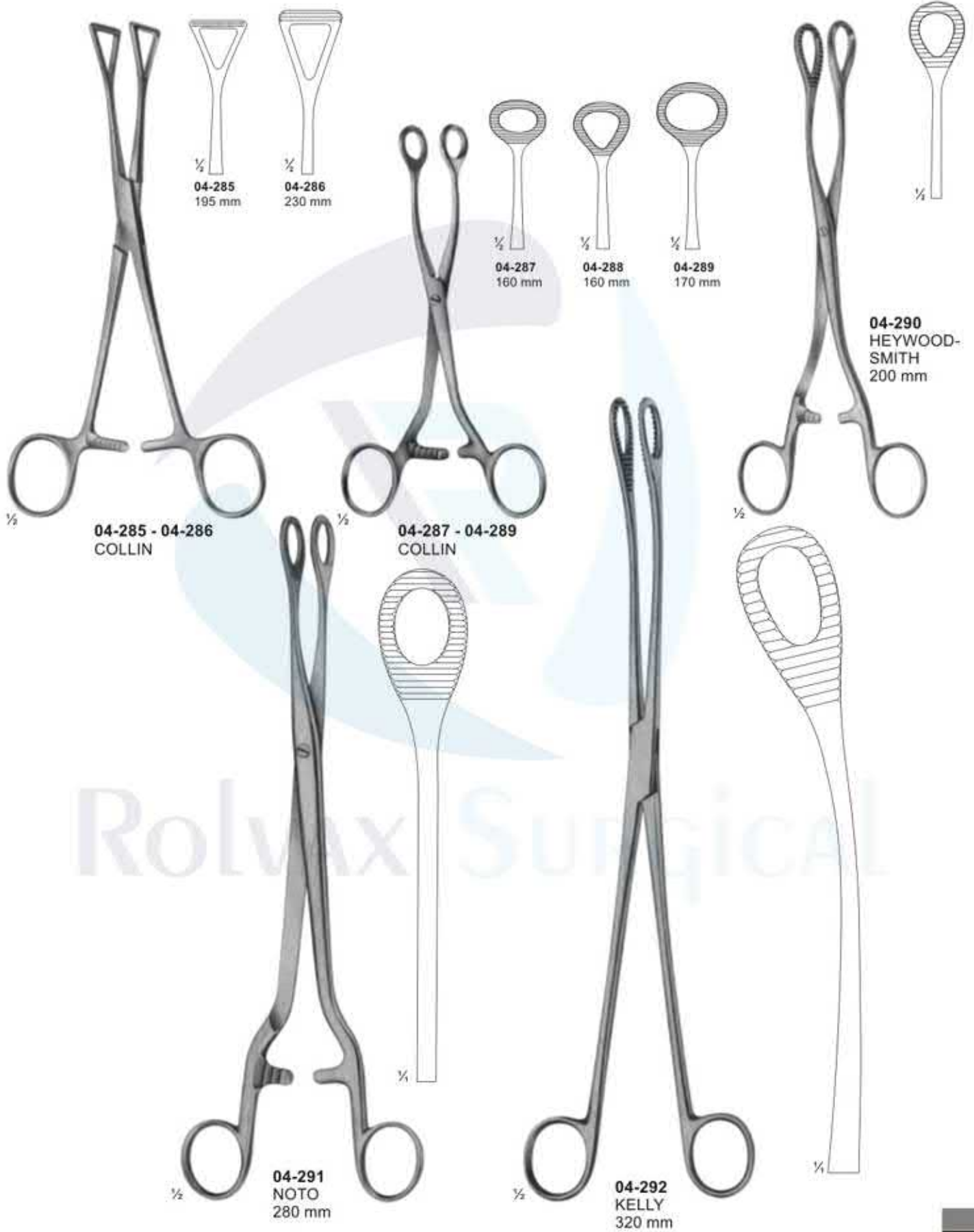

Dressing, Sponge holding, Organ and Tissue Grasping Forceps



04-293 - 04-294
FOERSTER-BALLENGER
180 mm



04-295 - 04-296
RAMPLEY



04-297 - 04-300
FOERSTER-BALLENGER
240 mm

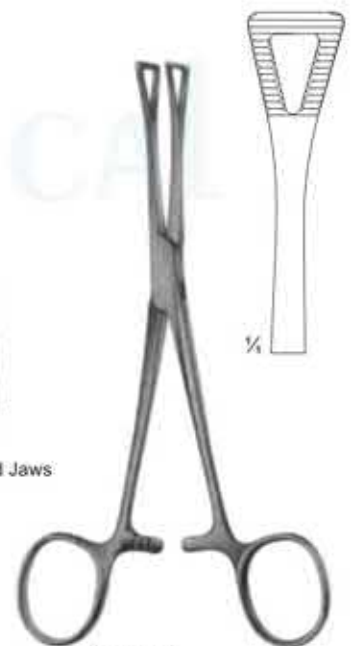

04-301
PENNINGTON
155 mm

Intestinal Grasping Forceps



Artery Traction - and Tissue Grasping Forceps



04-311
CHAPUT
2 x 3 teeth
125 mm

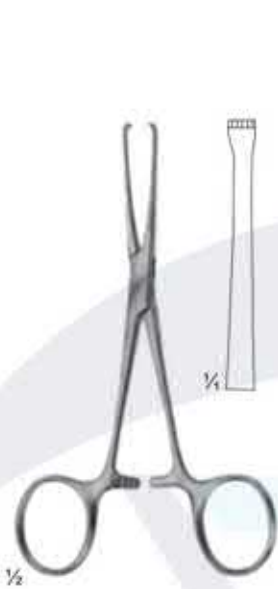

04-312
BABY-ALLIS
4 x 5 teeth
130 mm



04-313
BOYS-ALLIS
5 x 6 teeth sharp
155 mm

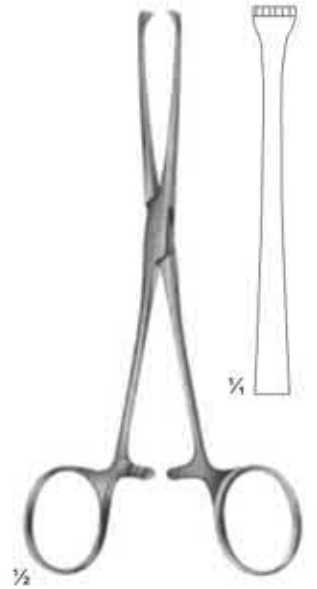

04-314
ALLIS
5 x 6 teeth
155 mm



04-315
LAHEY
155 mm



04-316
LAHEY
155 mm

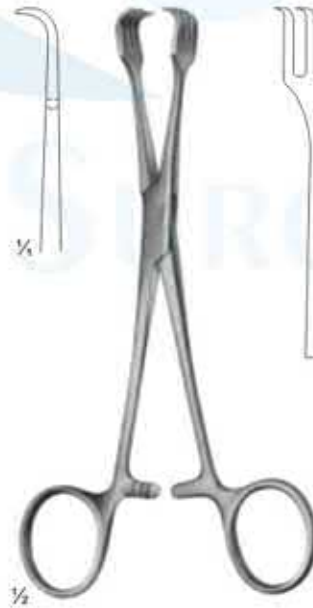

04-317
BRAUN
155 mm

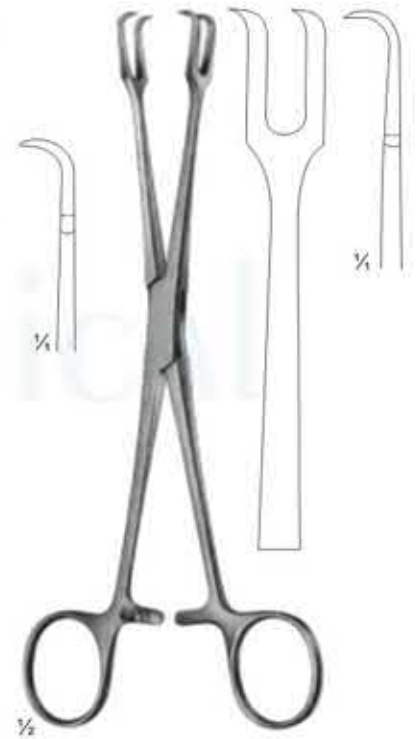

04-318
MUSEUX
200 mm

Towel Clamps

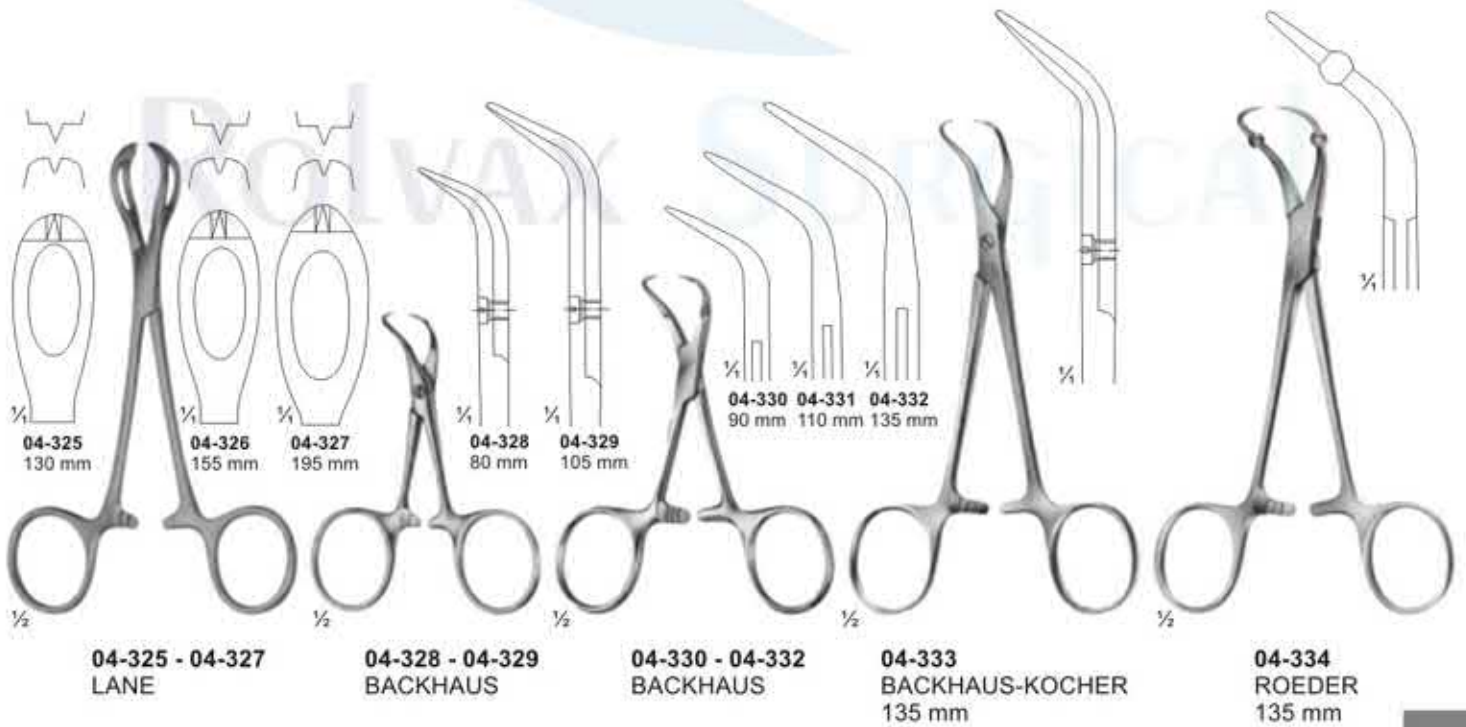

Muller Vessel Clips and Bulldog Clamps

Closing force



04-335 straight 80g 50g

04-336 curved 80g 50g

04-337 curved tips 80g 50g

04-338 angled shaped 80g 50g

04-339 MULLER knee-bent 80g 50g

04-340 Muller Ligature Forceps

Jaw, cross serrated

04-351 38 mm

04-352 48 mm

04-353 56 mm

04-354 63 mm

04-355 70 mm

04-356 80 mm

04-357 91 mm

04-341 35 mm

04-342 35 mm

04-343 45 mm

04-344 45 mm

04-345 DIEFFENBACH 38 mm

04-346 DIEFFENBACH 48 mm

04-347 DIEFFENBACH 38 mm

04-348 DIEFFENBACH 48 mm

04-349 DIEFFENBACH 58 mm

04-350 DIEFFENBACH 58 mm

04-351 - 04-357 JOHNS-HOPKINS 91 mm

04-358 DE BAKEY-HESS 20 mm

04-359 DE BAKEY length 50 mm jaws 27 mm

04-360 DE BAKEY length 48 mm jaws 27 mm

04-361 GLOVER length 57 mm jaws 35 mm

04-362 DE BAKEY length 73 mm jaws 38 mm

04-363 DE BAKEY length 99 mm jaws 63 mm

04-364 DE BAKEY length 95 mm jaws 54 mm

04-365 DE BAKEY L. 80 mm

04-366 DE BAKEY L. 90 mm

04-367 DE BAKEY L. 105 mm

04-368 DE BAKEY L. 124 mm

04-369 DE BAKEY L. 78 mm

04-370 DE BAKEY L. 86 mm

04-371 DE BAKEY L. 97 mm

04-372 DE BAKEY L. 114 mm

04-373 GLOVER L. 68 mm

04-374 GLOVER L. 96 mm

04-375 GLOVER L. 117 mm

04-376 GLOVER L. 65 mm

04-377 GLOVER L. 91 mm

04-378 GLOVER L. 110 mm

Delicate Haemostatic Forceps



Delicate Haemostatic Forceps



04-395
CARREL
85 mm



04-396 - 04-399
BABY-MOSQUITO
(HARTMANN)
100 mm



04-400 - 04-403
MICRO-HALSTED
125 mm



04-404 - 04-407
HALSTED-MOSQUITO
125 mm



04-408 - 04-409
PROVIDENCE-HOSPITAL
140 mm



04-410 - 04-411
KELLY
140 mm



04-412 - 04-413
DANDY
Curved sideways
140 mm

Delicate Haemostatic Forceps

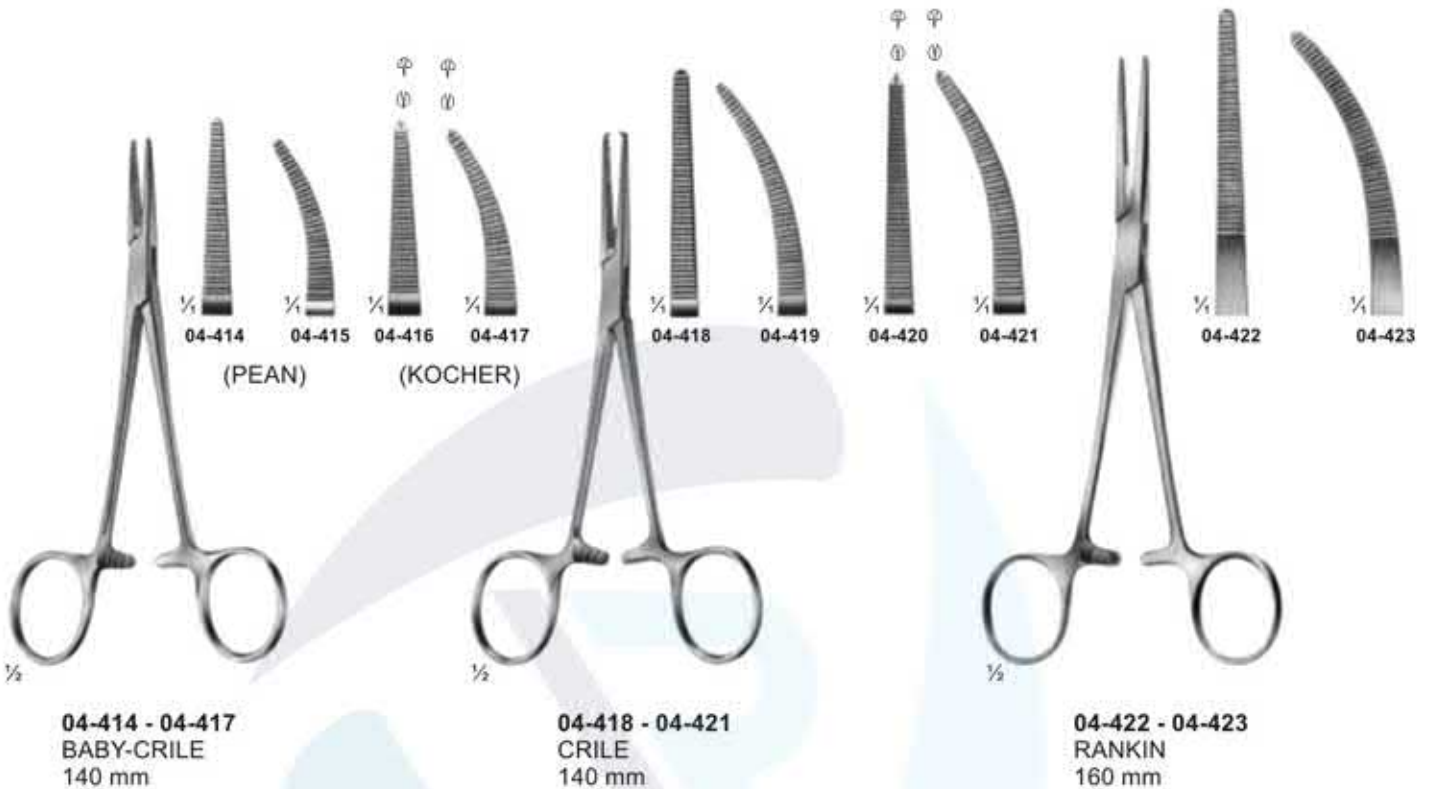

Haemostatic Forceps



04-434 - 04-437
PEAN
Slender type

04-438 - 04-445
SPENCER-WELLS
Slender type

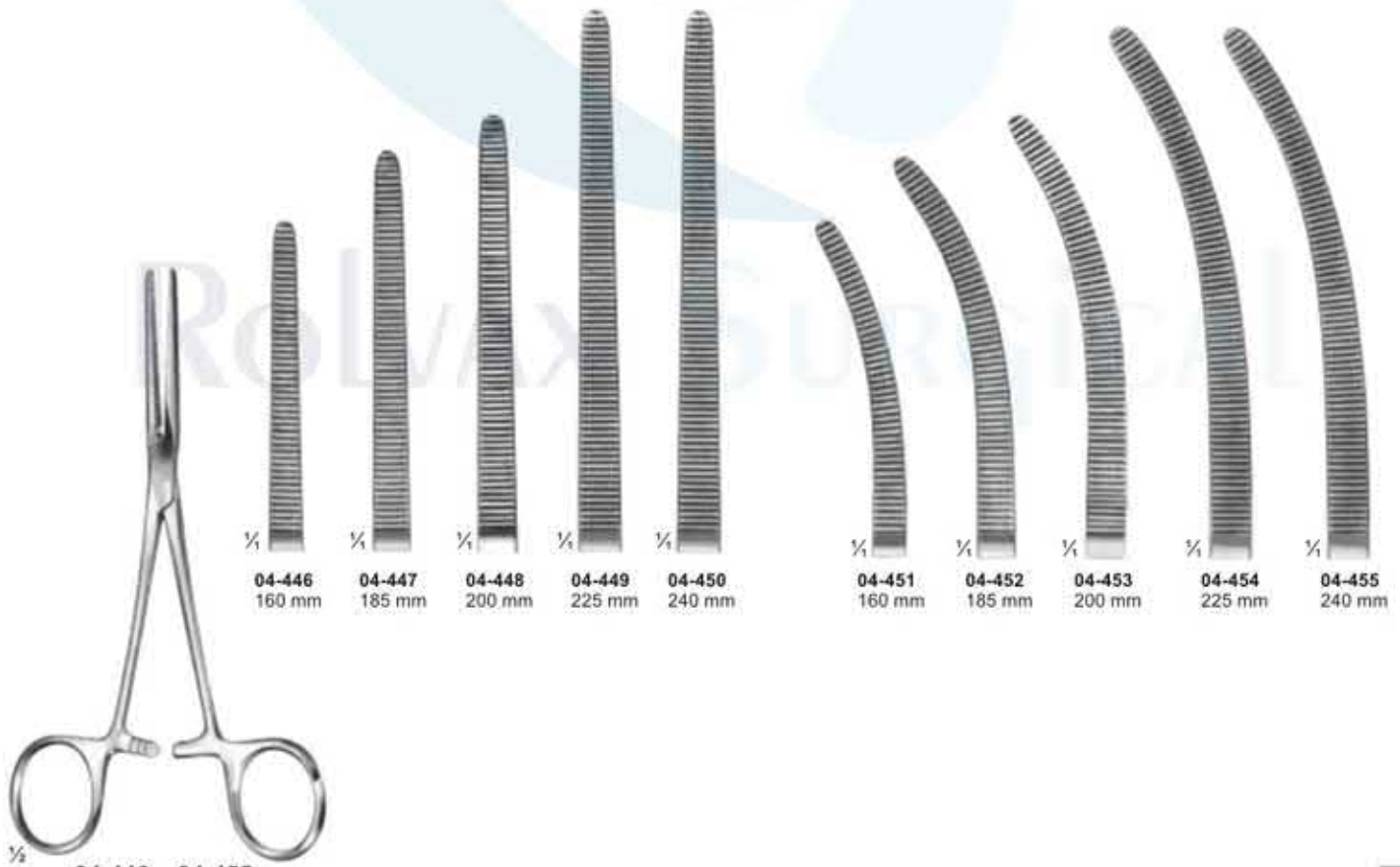

04-446 - 04-455
ROCHESTER-PEAN

Haemostatic Forceps



04-456 - 04-461
PEAN

04-456
240 mm

04-457
260 mm

04-458
280 mm

04-459
240 mm

04-460
260 mm

04-461
280 mm

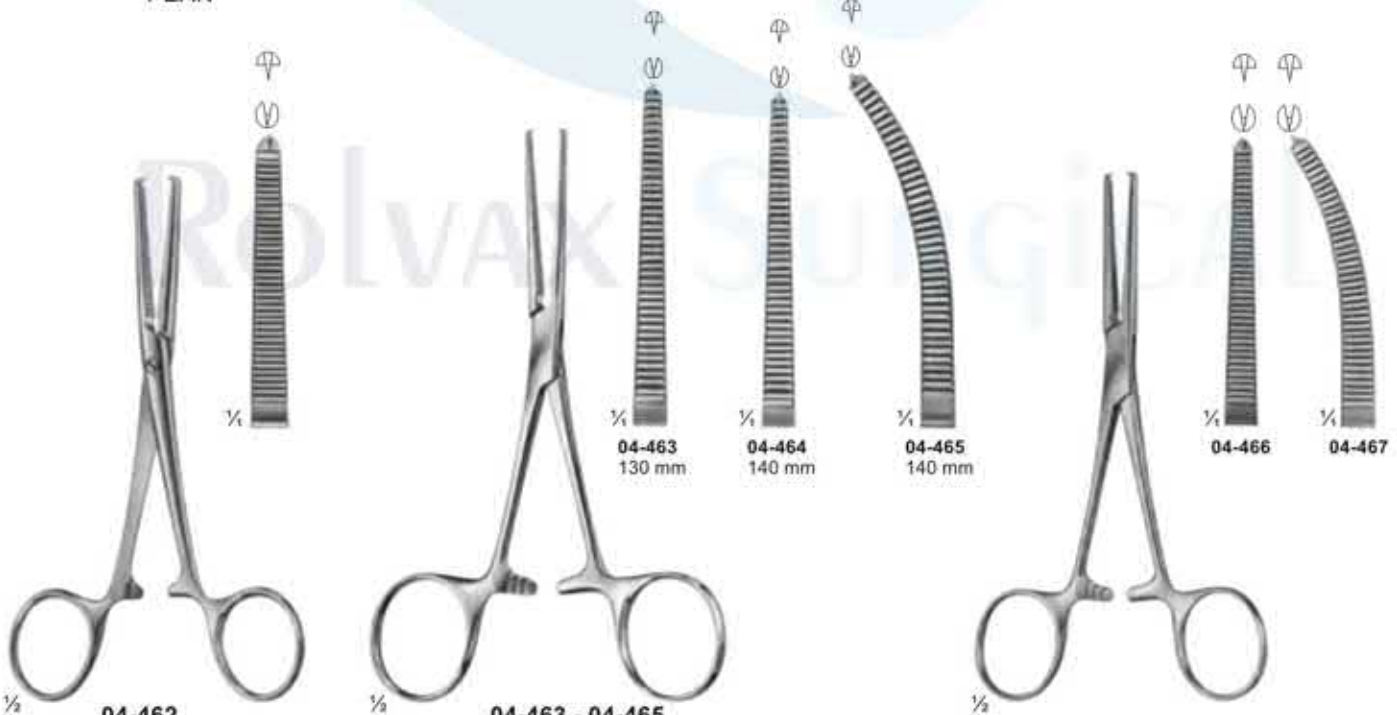

04-462
KOCHER
Strong Pattern
145 mm

04-463 - 04-465
KOCHER

04-463
130 mm

04-464
140 mm

04-465
140 mm

04-466 - 04-467
ROCHESTER-OSHSNER
140 mm

04-466

04-467

Haemostatic Forceps



04-468 160 mm 04-469 185 mm 04-470 200 mm 04-471 225 mm 04-472 240 mm 04-473 260 mm

04-474 160 mm 04-475 185 mm 04-476 200 mm 04-477 225 mm 04-478 240 mm 04-479 260 mm

04-468 - 04-479
KOCHER-OCHSNER

Haemostatic Forceps

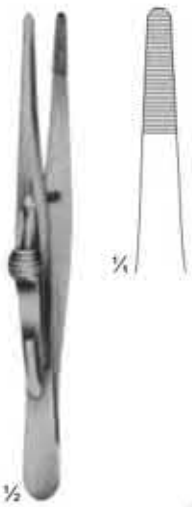

04-480
FRICKE
Artery forceps
130 mm



04-481
KRONLEIN
130 mm



04-482
PEAN
125 mm



04-483
125 mm



04-484
140 mm

04-483 - 04-484
PEAN



04-485
PEAN
125 mm



04-486
165 mm



04-487
185 mm

04-486 - 04-487
PEAN

Haemostatic Forceps, Special Pattern, Tonsil Forceps

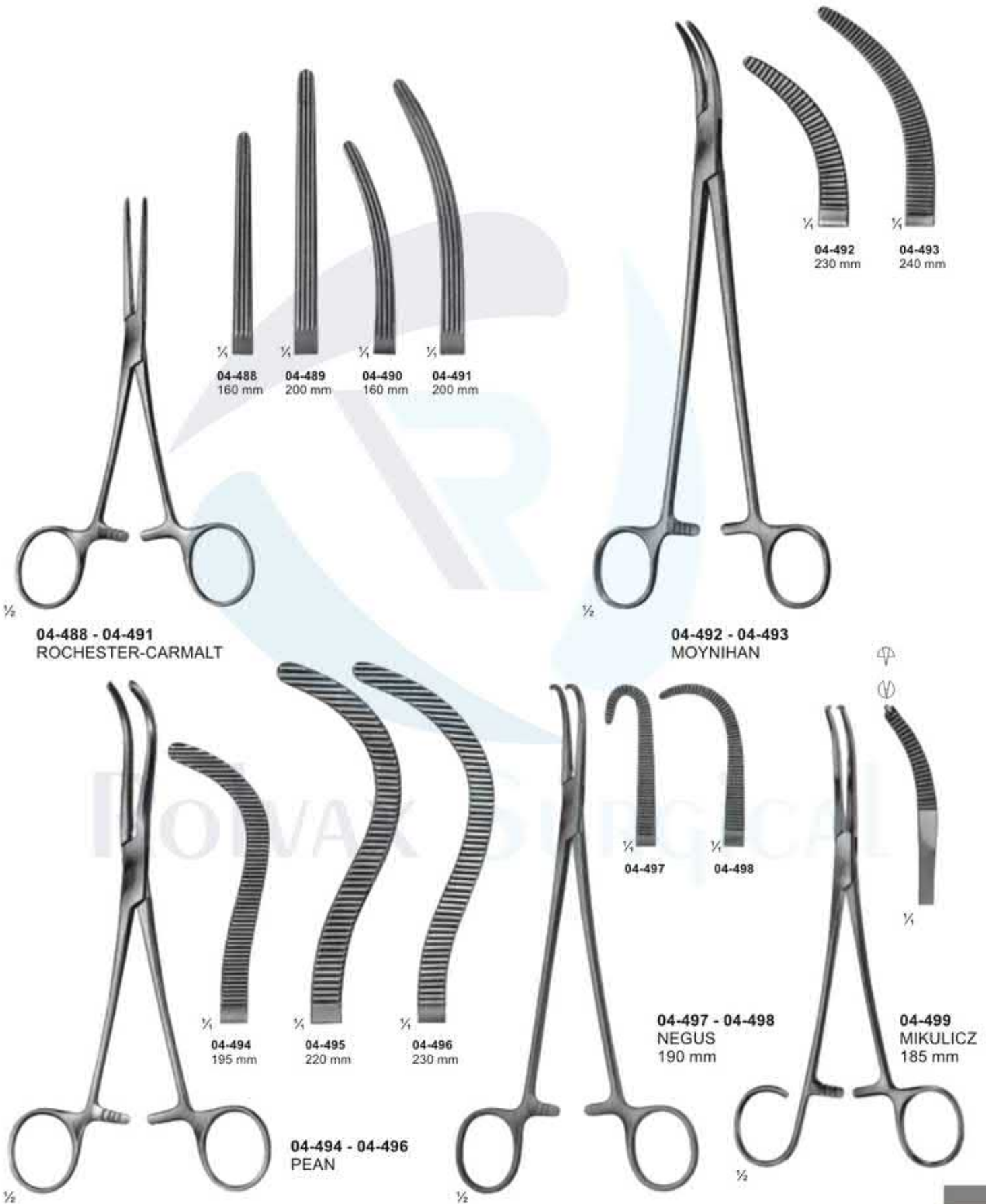

Dissecting- and Ligature Forceps



04-500
MIXTER-O'SHAUGHNESSY
190 mm



04-501
HEISS
195 mm



04-502 - 04-506
RUMEL
240 mm

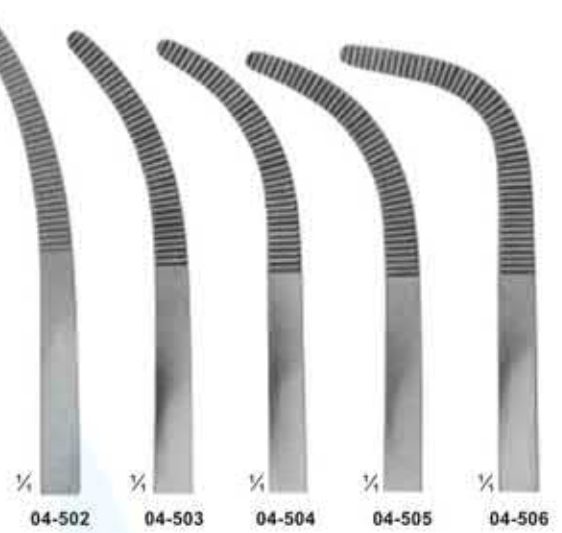

04-507
FINOCHIETTO
245 mm



04-508
MIXTER
230 mm



04-509
LAWRENCE
270 mm

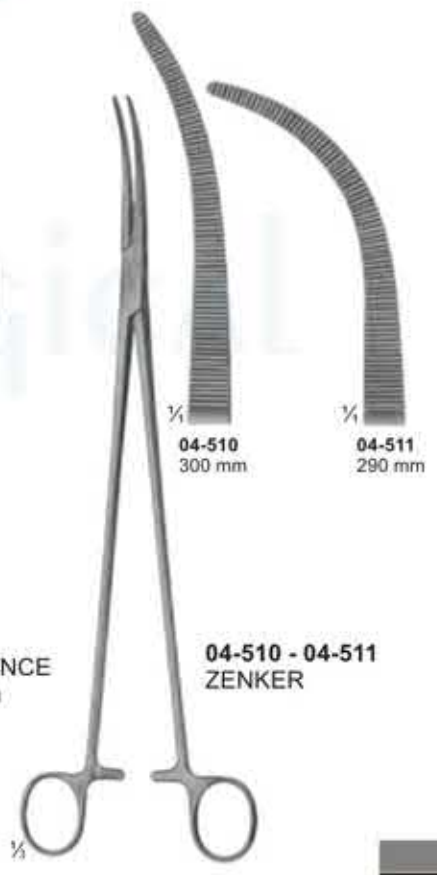

04-510 - 04-511
ZENKER

Hysterectomy Forceps, Vaginal Clamps and Compression Forceps



04-512
WERTHEIM
 Hysterectomy forceps
 255 mm



1/4

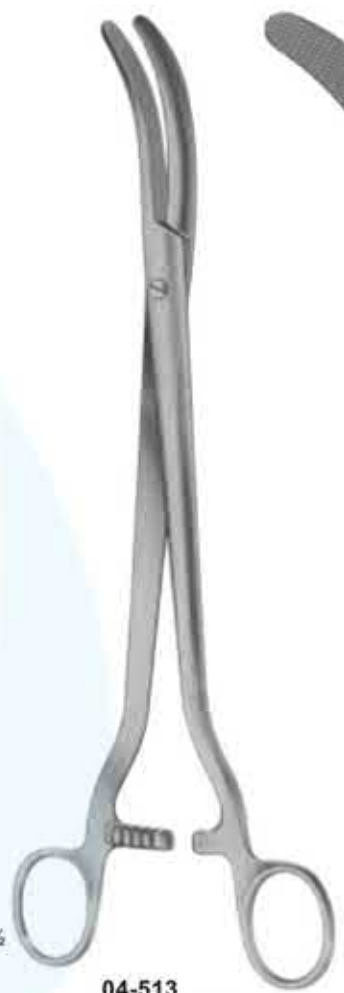

04-513
WERTHEIM
 Parametrium clamp
 260 mm



1/4



04-514 - 04-516
DICK



04-514
 255 mm

04-515
 265 mm

04-516
 275 mm

Hysterectomy Forceps, Vaginal Clamps
and Compression Forceps



04-517
WERTHEIM
250 mm

04-520
80 mm

04-519
60 mm



04-518
WERTHEIM-CULLEN
215 mm



04-519 - 04-520
230 mm

Needle Holders for micro surgery



05-101
ROHRSCHEIDER
with copper inserts
100 mm



05-102
KALT
with catch
135 mm



05-103
ARRUGA
with catch
135 mm



05-104 - 105
CASTROVIEJO
with catch
145 mm



05-106 - 107
without Catch
160 mm



05-108 - 109
without catch
185 mm



05-110 - 111
JACOBSON
185 mm



05-112
without catch
195 mm



05-113 - 114
YASARGIL
with catch
200 mm

Needle Holders



Needle Holders

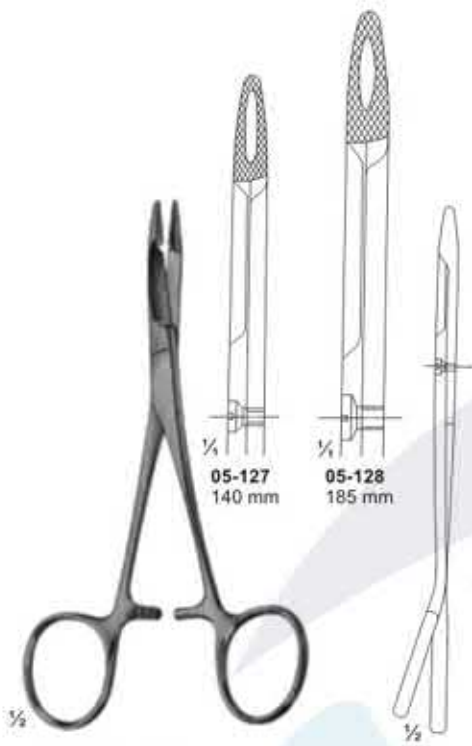

05-127 - 128
HEGAR-OLSEN
255 mm



05-129
GILLIES
150 mm



05-130
GILLIES
160 mm

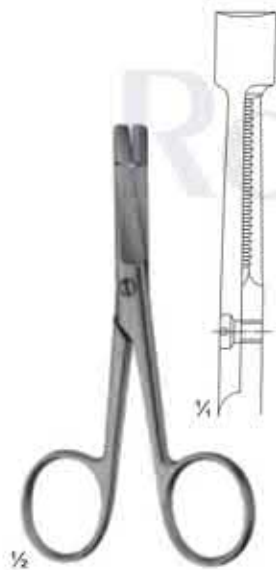

05-131
EISELSBERG
115 mm

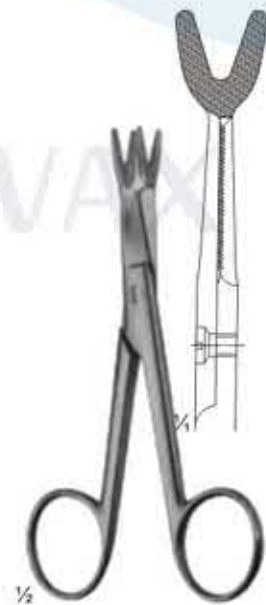

05-132
SCHOEMAKER-LOTH
125 mm



05-133
CRILE
150 mm



05-134
TOENNIS
Elastic pattern for dura-or
intestinal suture. 180 mm

Needle Holders

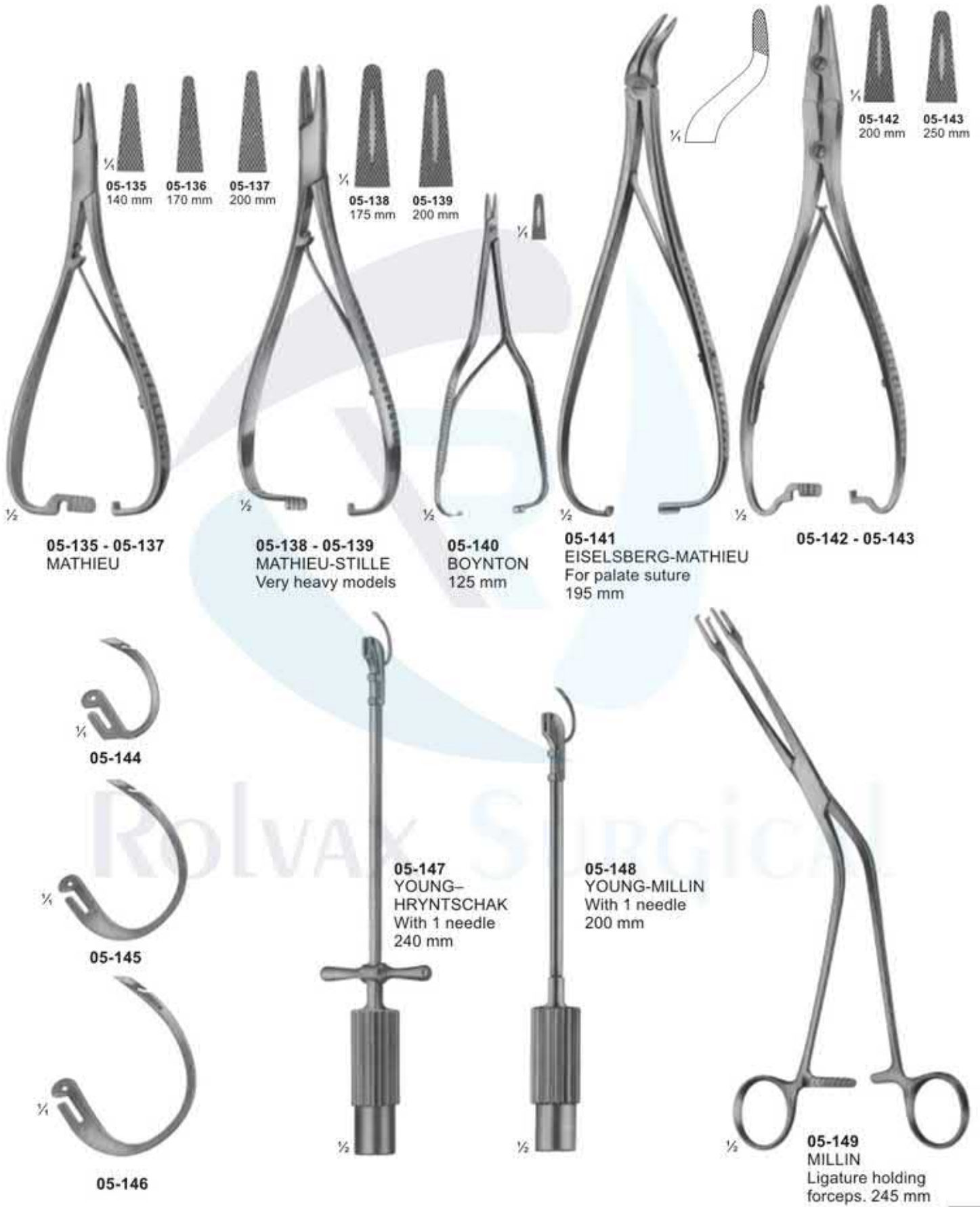

Suture Instruments - Reverdin Needles



Probes



05-162 130 mm
05-163 145 mm
05-164 160 mm
Directors



05-165
DOYEN
145 mm
Directors



05-166
NELATON
160 mm
Directors



05-167
Director with tip
Diam. Of tip 3,3 mm
140 mm

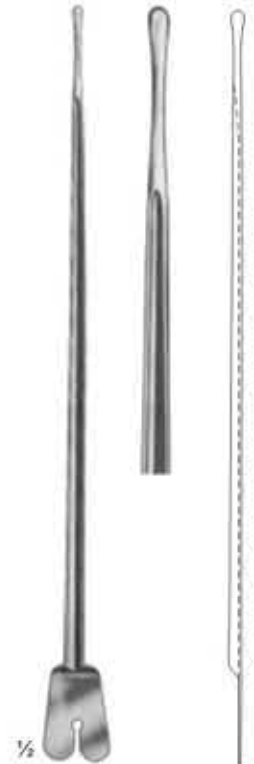

05-168
BRODIE
Director with tip,
Diam. Of tip 3,5 mm
200 mm



05-169
LOCKHART-MUMMERY
165 mm



05-170
LOCKHART-MUMMERY
165 mm

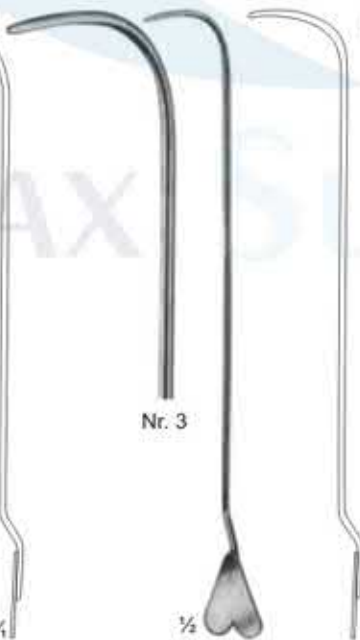

05-171
LOCKHART-MUMMERY
165 mm

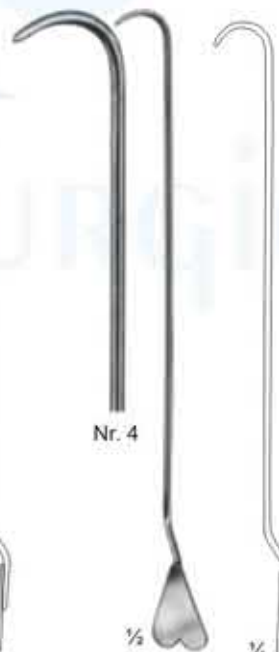

05-172
LOCKHART-MUMMERY
165 mm



05-173
Director with wire
loop, malleable
190 mm

Probes

05-174
2,5 mm
05-175
2,5 mm
05-176
3,0 mm



05-174 145 mm
05-175 160 mm
05-176 200 mm
Probes with eye

1,5 mm



05-177
Myrtle leaf probe.
145 mm

2,0 mm



05-178 130 mm
05-179 145 mm
05-180 160 mm
05-181 180 mm
05-182 200 mm



05-183
Probes

Rolvax SURGICAL



05-184 1/2
Double ended probe,
malleable, diam. of tips
3 mm with hole
190 mm



05-185
Double ended probes,
tin, malleable,
diam. of tips
3,5 mm with hole
250 mm, 300 mm



05-186 1/4
Double ended probes,
tin, malleable,
diam. of tips 4 mm
400 mm



1/2 ∅ tip
05-187 1,5 mm
05-188 2,0 mm
05-189 2,5 mm
300 mm

Suturing Instrument Set, Pocket Instrument Set



05-190

Suturing instruments set, in metal case consisting of: Scissors, curved, sharp/sharp, 115mm
25 MICHEL clip, 16 x 3mm
1 Delicate tissue forceps, 130mm
1 Scalpel, bellied
1 MATHIEU needle holder, 140mm
1 Perforated metal case, stainless containing:
1 Suture needle
1 item 1 item



05-191

Pocket instrument set, in metal case consisting of:

Bottom tray

1 MATHIEU needle holder, 140mm
1 MICHEL clip forceps, combined
1 Myrtle leaf probe, 130mm
1 Sharp double curette
1 Skin hook
1 Detachable scalpel handle, no.4
1 Perforated metal case, containing
6 Scalpel blades
1 Perforated metal case, stainless, containing
1 Suture needle
1 item
1 item

Top tray

1 Tissue forceps, 130mm
1 KOCHER haemostatic forceps, 130mm
1 Straight surgical scissors, 130mm
1 Dissecting forceps, 130mm
1 FEILCHENFELD splinter forceps, 115mm
25 MICHEL clip, 16 x 3mm
1 Flacon of suture skin, sterile in alcohol



05-192

Pocket instrument set, in metal case consisting of:

Bottom tray

1 MAYO-HEGER needle holder, 150mm
1 MICHEL clip forceps, combined
1 Myrtle leaf probe, 130mm
1 Sharp double curette
1 Skin hook
1 Detachable scalpel handle, no. 4
1 Perforated metal case, consisting
6 Scalpel blades
1 Perforated metal case, stainless, consisting:
1 Suture needle
1 item, & 1 item

Top tray

1 Tissue forceps, 130mm
1 CRILE haemostatic forceps, 140mm
1 Straight surgical scissors, 130mm
1 Dissecting forceps, 130mm
1 FEILCHENFELD splinter forceps, 115mm
25 MICHEL clip, 16 x 3mm
1 Flacon of suture silk, sterile in alcohol



Fine Wound Retractors (Dura- and Skin Retractors)



Retractors With treangle handle

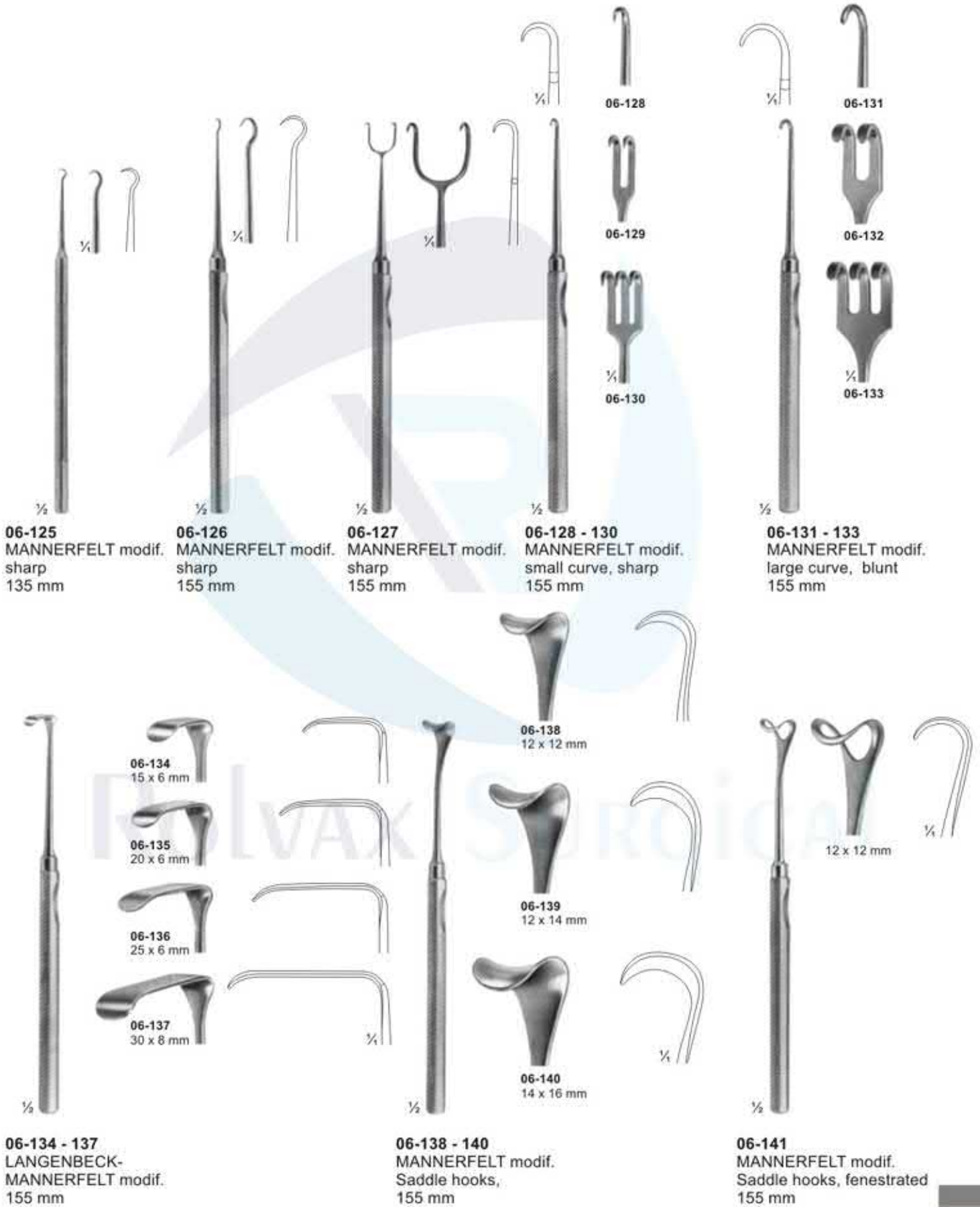

Retractors



Retractors



Retractors



Bone Retractors and Retractors



06-184
KOCHER
sharp
205 mm



06-185
KOCHER
sharp
220 mm



06-186
KOCHER
sharp
220 mm



06-187
VOLKMANN
blunt
220 mm



06-188
VOLKMANN
sharp
220 mm



06-189 - 06-196
VOLKMANN
225 mm



06-189
9 x 8 mm



06-190
9 x 13 mm



06-191
9 x 19 mm



06-192
9 x 29 mm



06-193
8,5 x 8 mm



06-194
8,5 x 13 mm



06-195
8,5 x 19 mm



06-196
8,5 x 29 mm

Retractors



Retractors, Vario Retractor System



06-203 80 x 20 mm

- 06-203-06-209
- BRUNNER
- 275 mm
- 06-203 80 x 20
- 06-204 100 x 25
- 06-205 120 x 25
- 06-206 130 x 30
- 06-207 140 x 30
- 06-208 160 x 30
- 06-209 180 x 30

06-210
Handle with cold
light carrier for
retractor blades.
280 mm

Handle arrange-
ment verriable

Retractors, Lung Spatulas



**Retractors for deep surgery
(Abdominal Retractors)**



Retractors, Abdominal Retractors



- 06-229 Fig.1 32 x 40 mm
- 06-230 Fig.2 34 x 50 mm
- 06-231 Fig.3 41 x 60 mm
- 06-232 Fig.4 46 x 75 mm
- 06-233 Fig.5 64 x 85 mm

06-218 - 06-228
DOYEN
240 mm

06-229 - 06-233
FRITSCH
240 mm

06-234
DOYEN
250 mm

length of blades	
62 mm	06-218 , 06-222 , 06-226
92 mm	06-219 , 06-223 , 06-227
122 mm	06-220 , 06-224 , 06-228
160 mm	06-221 , 06-225
width of blades	
35 mm, 45 mm, 60 mm	

Abdominal- and Intestinal Spatulas
Bauch- und Darmspatel



06-235
LERICHE
 255 mm

06-236
KUMMEL
 Mealleable
 285 mm

06-237
MIKULICZ
 29 mm
 250 mm

06-238 - 06-239
KADER
06-238 30 mm
06-239 40 mm
 270 mm

Self-Retaining Retractors

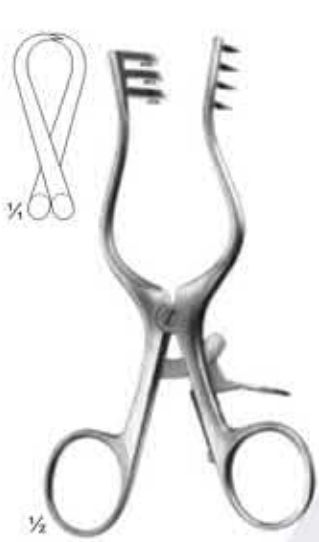

06-240
WEITLANER
sharp
130 mm

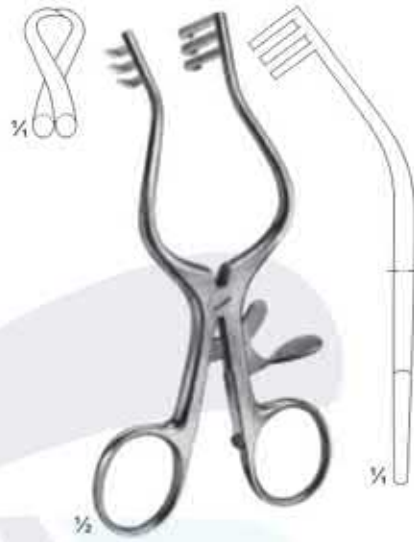

06-241
WULLSTEIN
sharp
130 mm

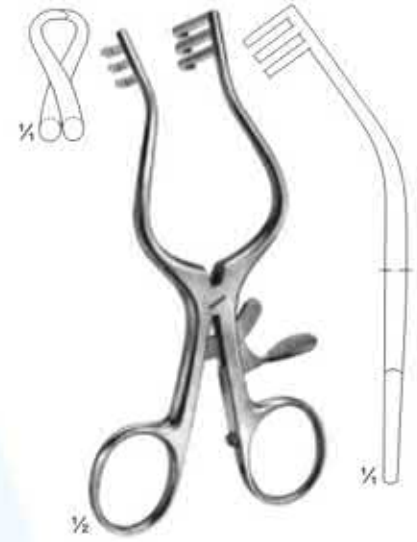

06-242
WULLSTEIN
blunt
130 mm



06-243
WEITLANER
sharp
165 mm



06-244
PLESTER
blunt
110 mm



06-245
PERKINS
130 mm

Special Retractors



06-246
JOLL (FRIEDMAN)
 Thyroid- and vaginal retractor
 155 mm

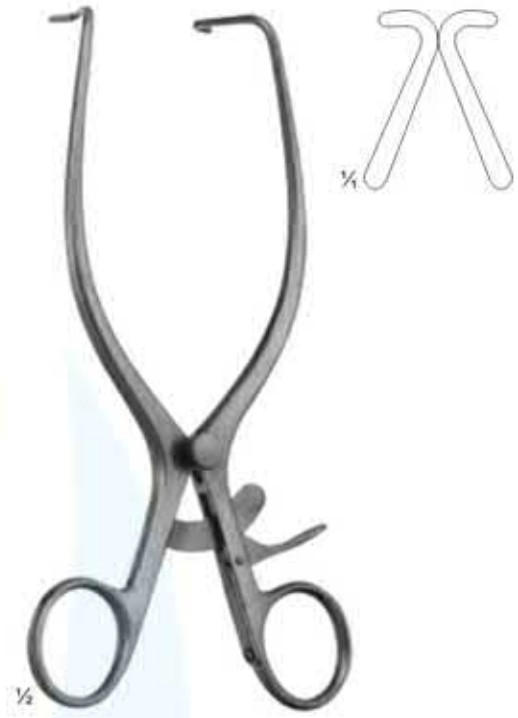

06-247
JACKSON BURROWS
 Retractor, blunt
 185 mm

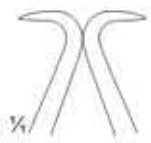
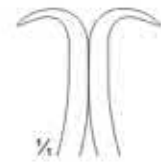

06-248
GELPI
 Vaginal retractor
 135 mm



06-249
GELPI
 Skin- and vaginal retractor
 175 mm



06-250
DE BAKKEY
 Femur retractor
 145 mm

Lamina Spreaders



06-251
CLOWARD
155 mm



06-252
CLOWARD
135 mm



06-253
INGE
170 mm

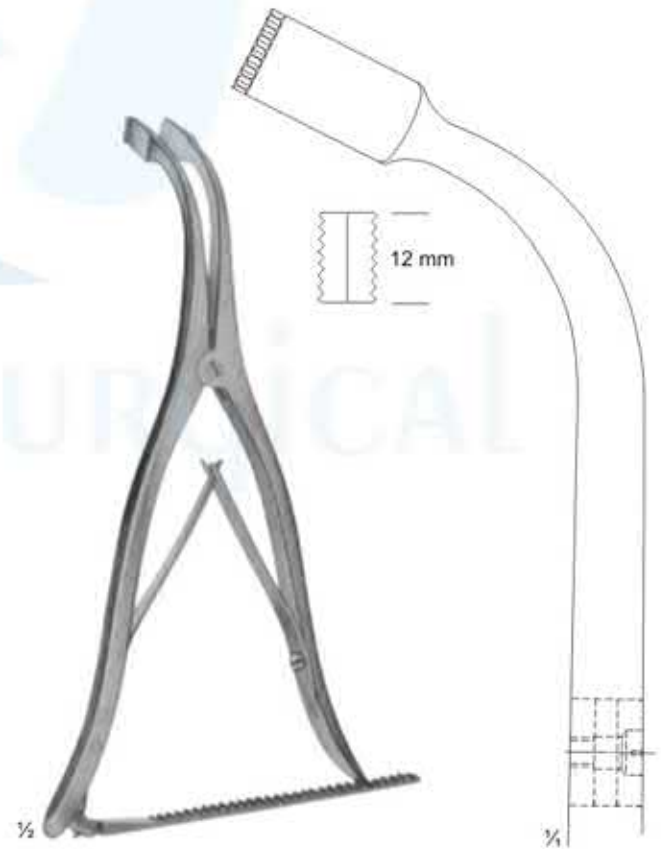

06-254
INGE
275 mm

Abdominal Retractors



06-255
GOSSET
Blades: 38 mm deep

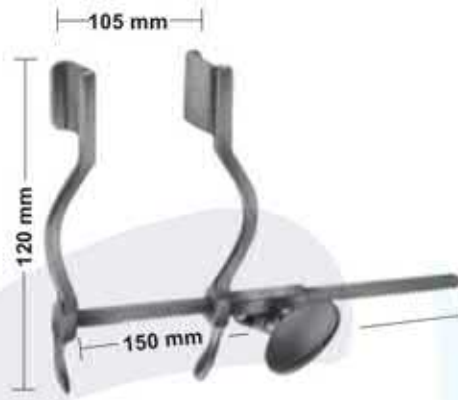

06-256
HERTZLER
Blades 20 X 25 mm

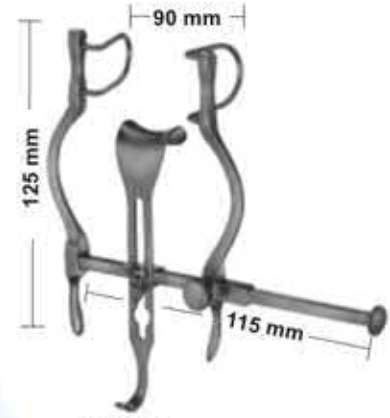

06-257
BALFOUR-BABY
Lateral blades 27 mm deep
Center blade 21x24 mm



06-258
GOSSET
Blades: 55 mm deep

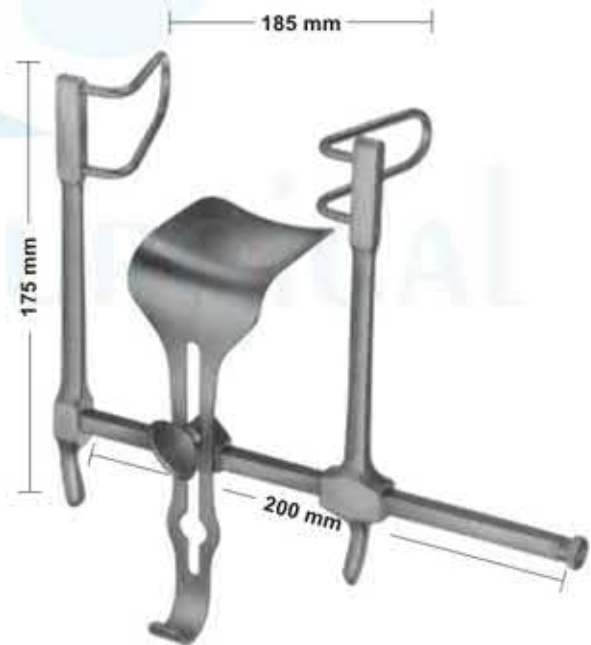

06-259
GOSSET
Lateral blades 58 mm deep
Center blade 59 x 57 mm

Abdominal Retractors

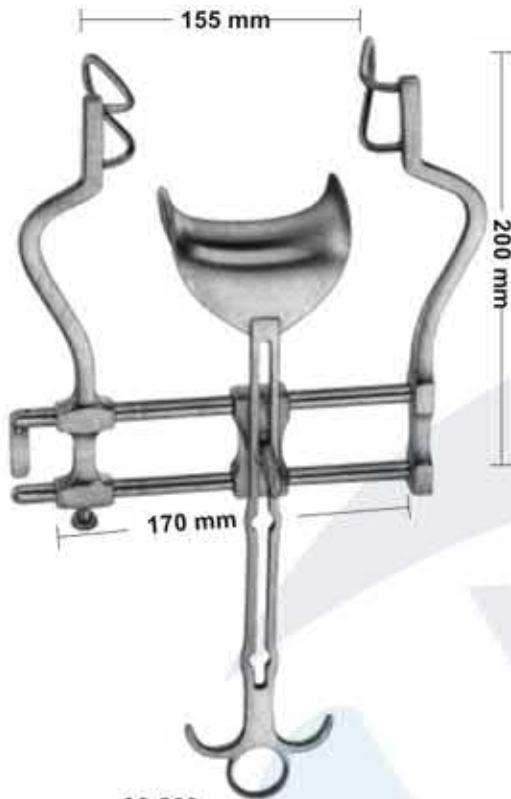

06-260
BALFOUR
Lateral blades 60 mm deep
Center blade 47 x 80 mm

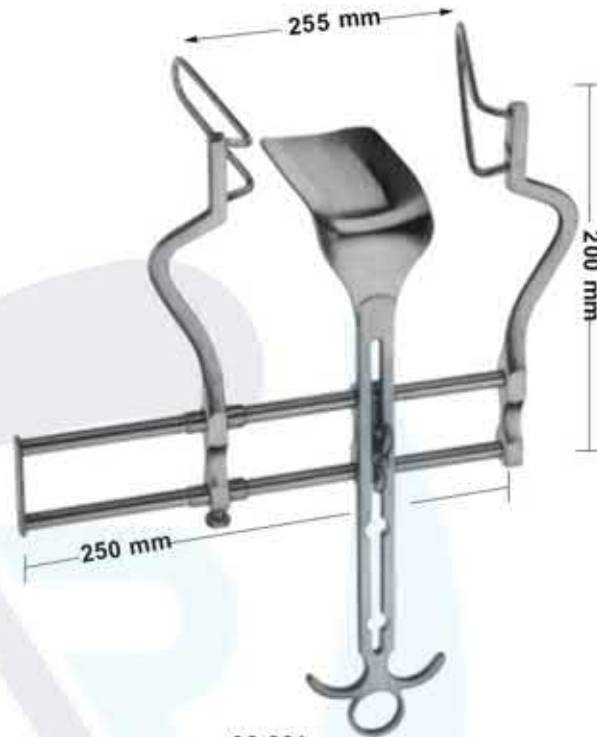

06-261
BALFOUR
Lateral blades 105 mm deep
Center blade 107x 59 mm



06-262
Center blade only
54x80 mm

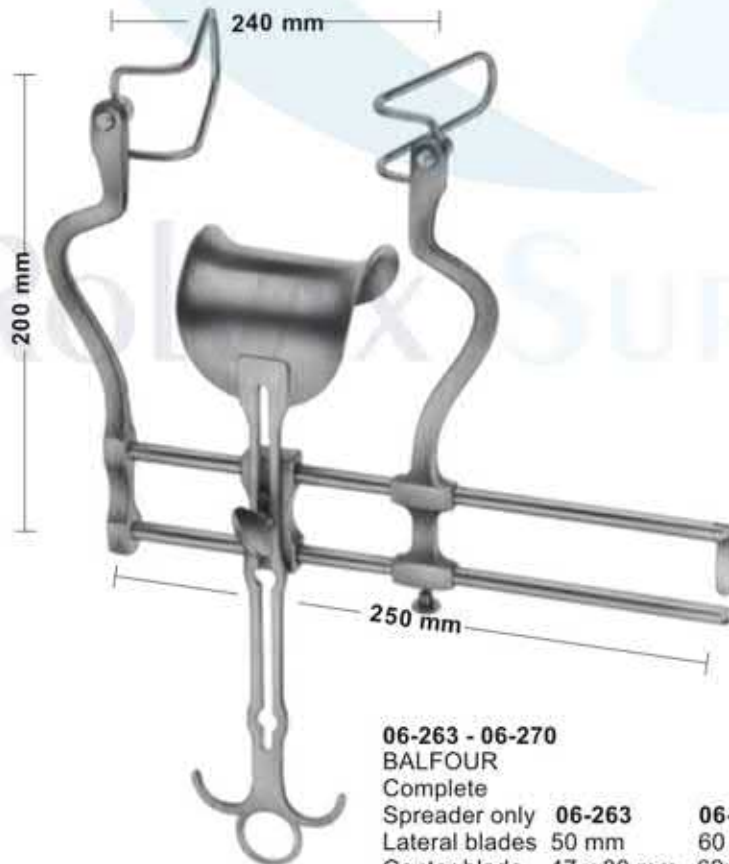

06-263 - 06-270
BALFOUR
Complete

Spreader only	06-263	06-264	06-265	06-266
Lateral blades	50 mm	60 mm	75 mm	90 mm
Center blade	47 x 80 mm	62x76 mm	80x80 mm	80x80 mm



Lateral blades
06-267 50 mm deep
06-268 60 mm deep
06-269 75 mm deep
06-270 90 mm deep

Sales Unit of blades: PR = pair

Organ-, Tissue and Intestinal Grasping Forceps



Intestinal Clamps, soft elastic

ATRAUMATA



07-110 - 111
DOYEN
elastic
165 mm

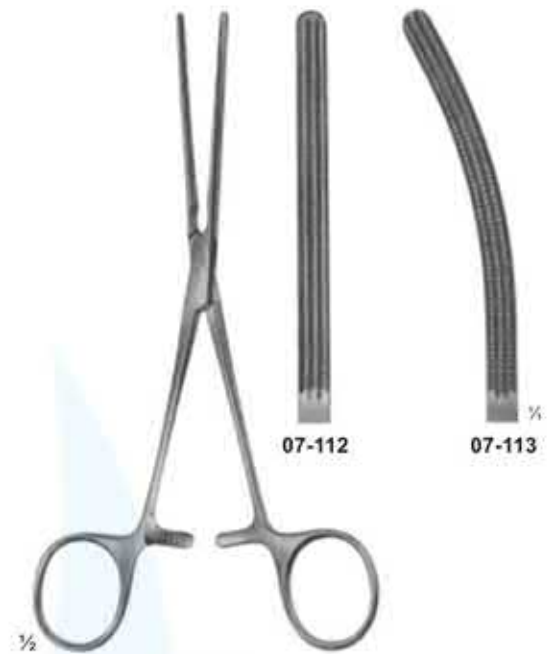

07-112 - 113
DOYEN
with elastic blades
170 mm

ATRAUMATA



07-114 - 115
HARTMANN
with elastic blades
200 mm



07-116 - 117
HARTMANN
with elastic blades
200 mm

Intestinal and Pylorus Clamps



07-118
PAYR
Intestinal clamp
light pattern,
for children
180 mm

07-119
PAYR
200 mm

07-120
PAYR
275 mm

07-121
PAYR
Pylorus clamp
315 mm

ATRAUMATA
Sigmoid Anastomosis Forceps

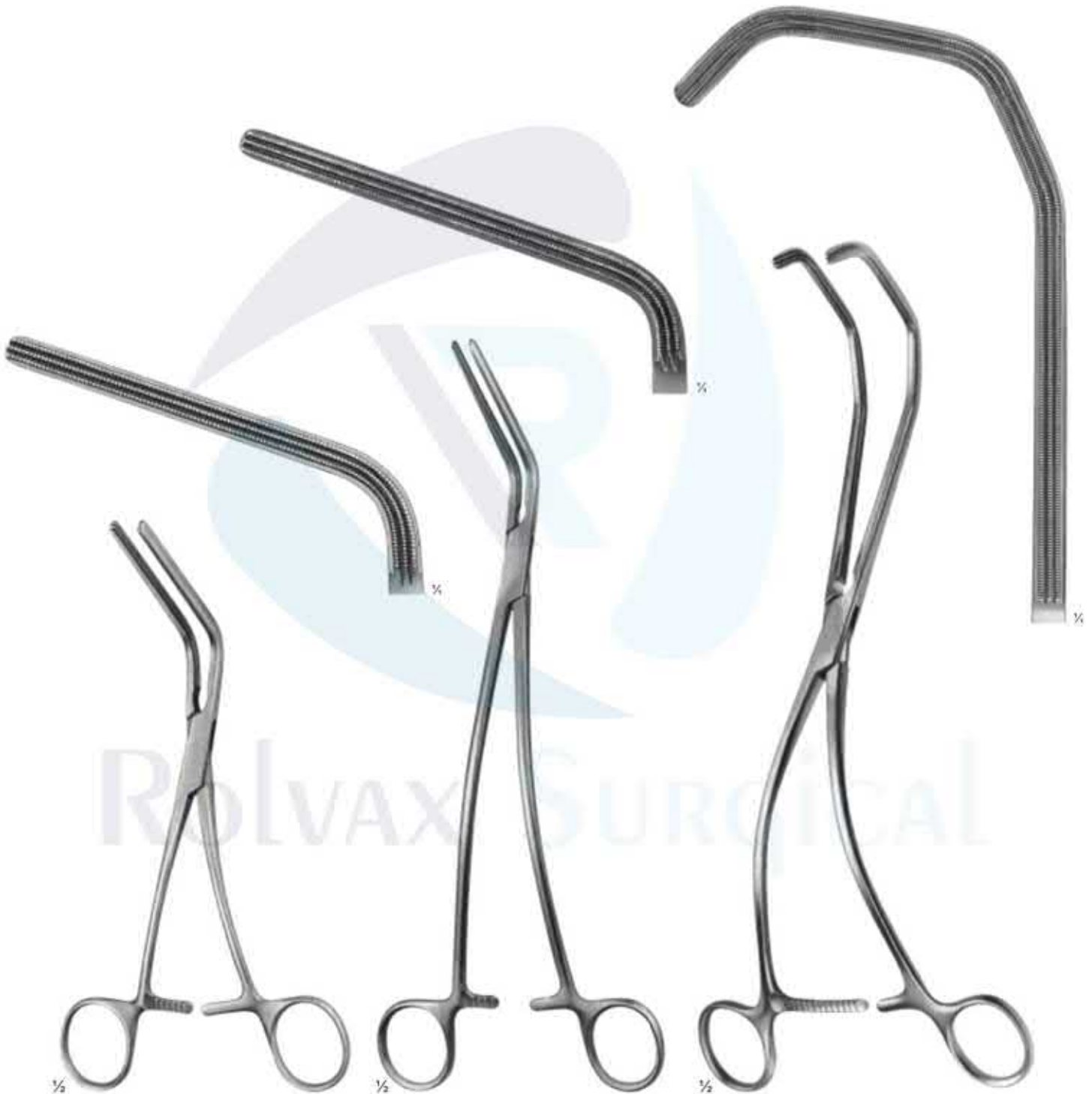

07-122
MORRIS
175 mm

07-123
DE BAKEY
(MORRIS modif.)
240 mm

07-124
KERSTING
270 mm

Nasal Specula



08-101
Martin
13 cm / 5 1/8"



08-102
SIMS
160 mm

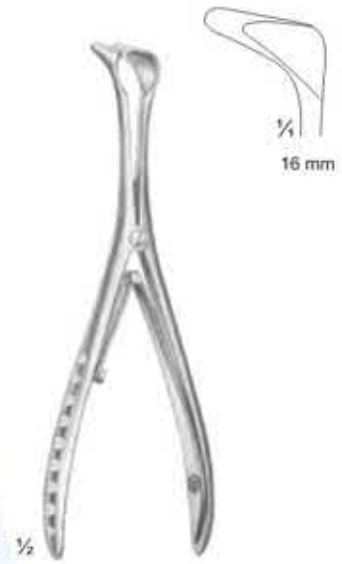

08-103
Tieck-Halle
13 cm / 5 1/8"



08-104
Killian

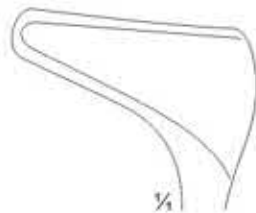

Fig. 1
14 cm 5 4/8"
35 mm

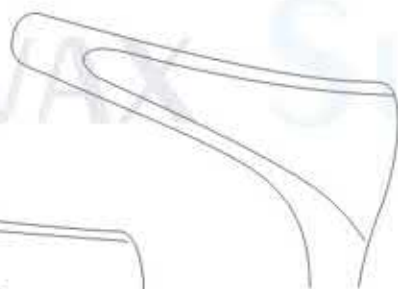

Fig. 2
14,5 cm / 5 4/8"
50 mm

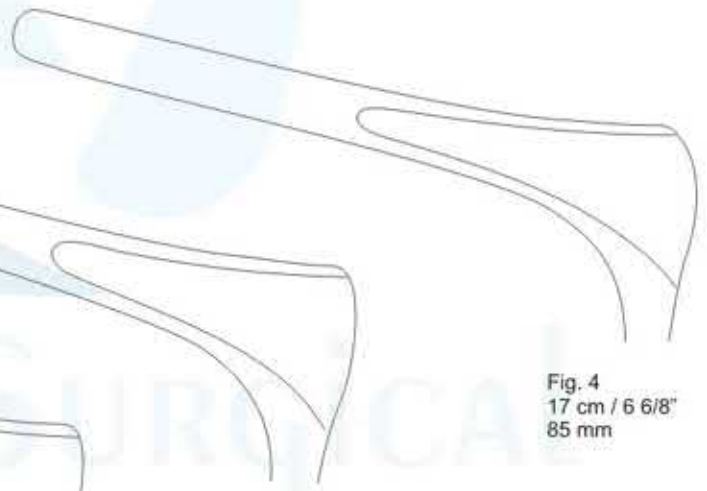
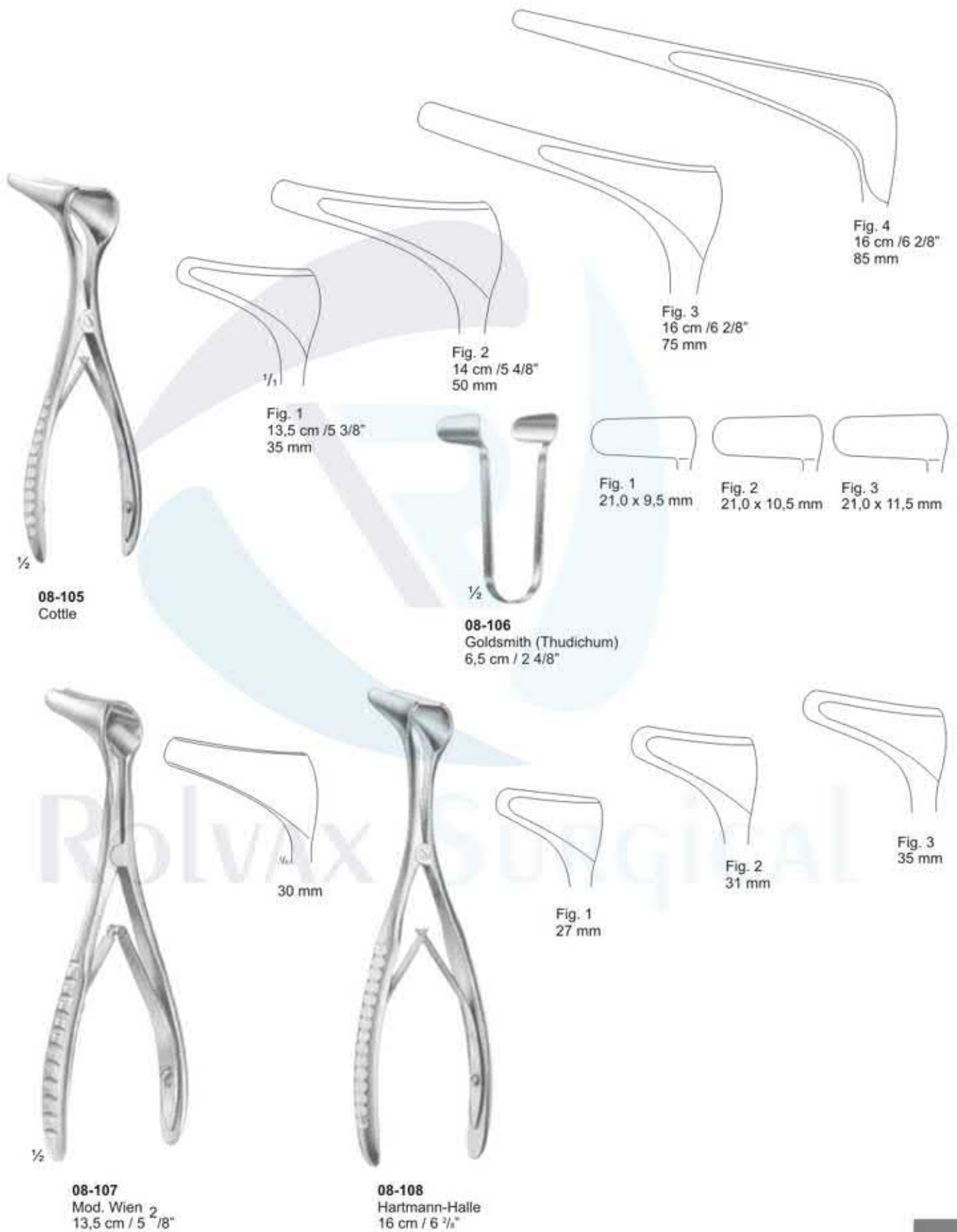

Fig. 3
16 cm / 6 2/8"
75 mm

Fig. 4
17 cm / 6 6/8"
85 mm

Nasal Specula



Anuscopy-Sphincteroscopes



08-109
IVES-FANSLER
Anuscopy
145 mm
Ø24mm



08-110
KELLY
Sphincteroscope
160 mm
Ø21mm



08-111
KELLY
Sphincteroscope
160 mm
Ø27mm



08-112
KELLY
Proctoscope
140 mm
Ø22mm

Haemorrhoidal Forceps

ATRAUMATA

Pressure Clamp



08-113 - 08-114
250 mm
270 mm

08-115 - 08-116
FERGUSSON
200 mm

08-117
RUDD
Haemorrhoidal ligator
with loading
attachment and 100
ligature rubber rings
315 mm

Gall Duct Forceps



08-118
LOWER
180 mm



08-119
LAHEY (SWEET)
190 mm



08-120
LAHEY
220 mm



08-121
DESJARDINS
Gall duct-and cystic forceps
210 mm



08-122
NISSEN
Gall duct-and cystic forceps
215 mm

Gall Duct Dilators and Gall Stone Scoops

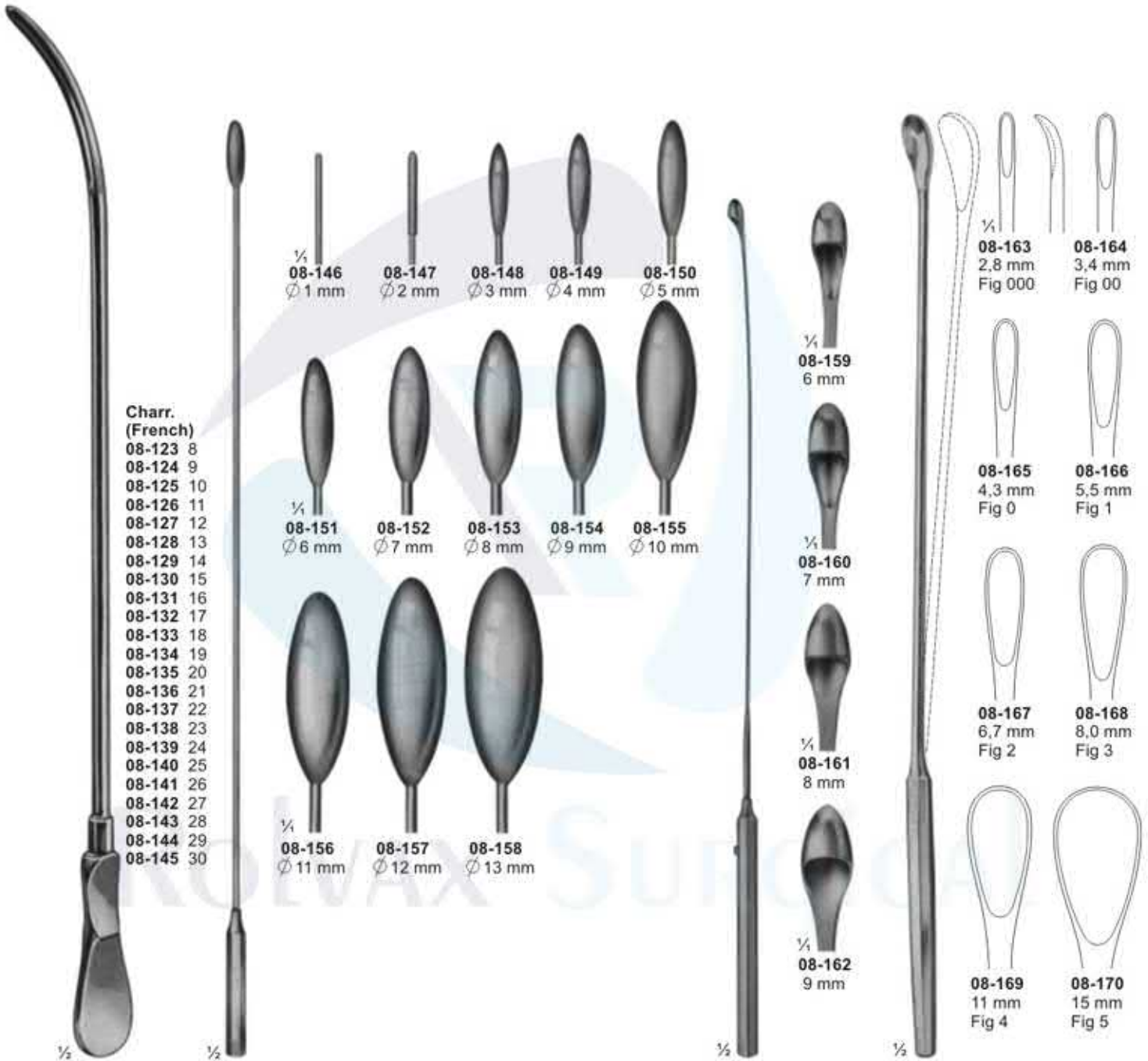

**Charr.
(French)**
 08-123 8
 08-124 9
 08-125 10
 08-126 11
 08-127 12
 08-128 13
 08-129 14
 08-130 15
 08-131 16
 08-132 17
 08-133 18
 08-134 19
 08-135 20
 08-136 21
 08-137 22
 08-138 23
 08-139 24
 08-140 25
 08-141 26
 08-142 27
 08-143 28
 08-144 29
 08-145 30

1/4
08-146
 Ø 1 mm

08-147
 Ø 2 mm

08-148
 Ø 3 mm

08-149
 Ø 4 mm

08-150
 Ø 5 mm

1/4
08-151
 Ø 6 mm

08-152
 Ø 7 mm

08-153
 Ø 8 mm

08-154
 Ø 9 mm

08-155
 Ø 10 mm

1/4
08-156
 Ø 11 mm

08-157
 Ø 12 mm

08-158
 Ø 13 mm

1/4
08-159
 6 mm

1/4
08-160
 7 mm

1/4
08-161
 8 mm

1/4
08-162
 9 mm

1/4
08-163
 2,8 mm
 Fig 000

08-164
 3,4 mm
 Fig 00

08-165
 4,3 mm
 Fig 0

08-166
 5,5 mm
 Fig 1

08-167
 6,7 mm
 Fig 2

08-168
 8,0 mm
 Fig 3

08-169
 11 mm
 Fig 4

08-170
 15 mm
 Fig 5

08-123 - 08-145
DITTEL
 Metall bougies and
 dilating sounds, stiff
 345 mm

08-146 - 08-158
BAKES
 Common bile duct
 dilators, malleable
08-146 - 08-150 315 mm
08-151 - 08-158 320 mm

08-159 - 08-162
DESJARDINS
 Probe and catch
 with flexible schaft
 300 mm

08-163 - 08-170
LUER-KOERTE modif
 with malleable shaft
 310 mm

Gall Stone Forceps

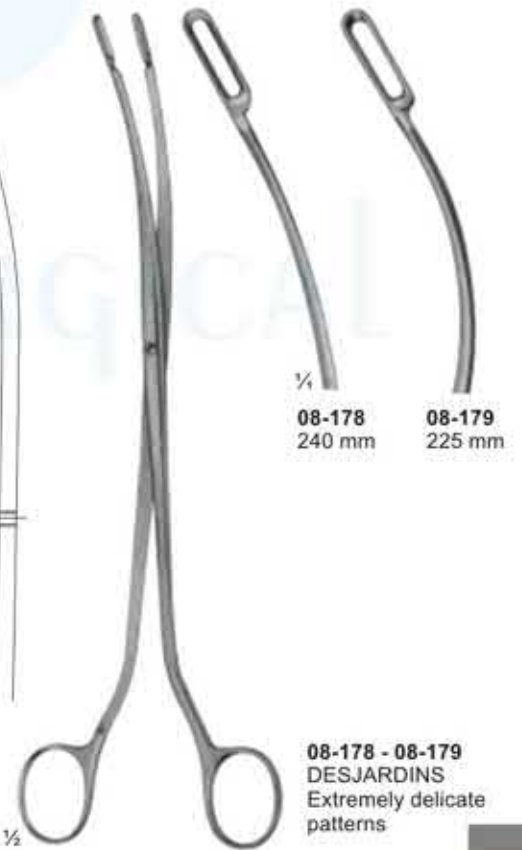

Kidney Clamps

ATRAUMATA



Kidney Stone Forceps



08-186 - 08-189
RANDALL
225 mm

08-190 - 08-192
RANDALL
190 mm

Bladder Retractors

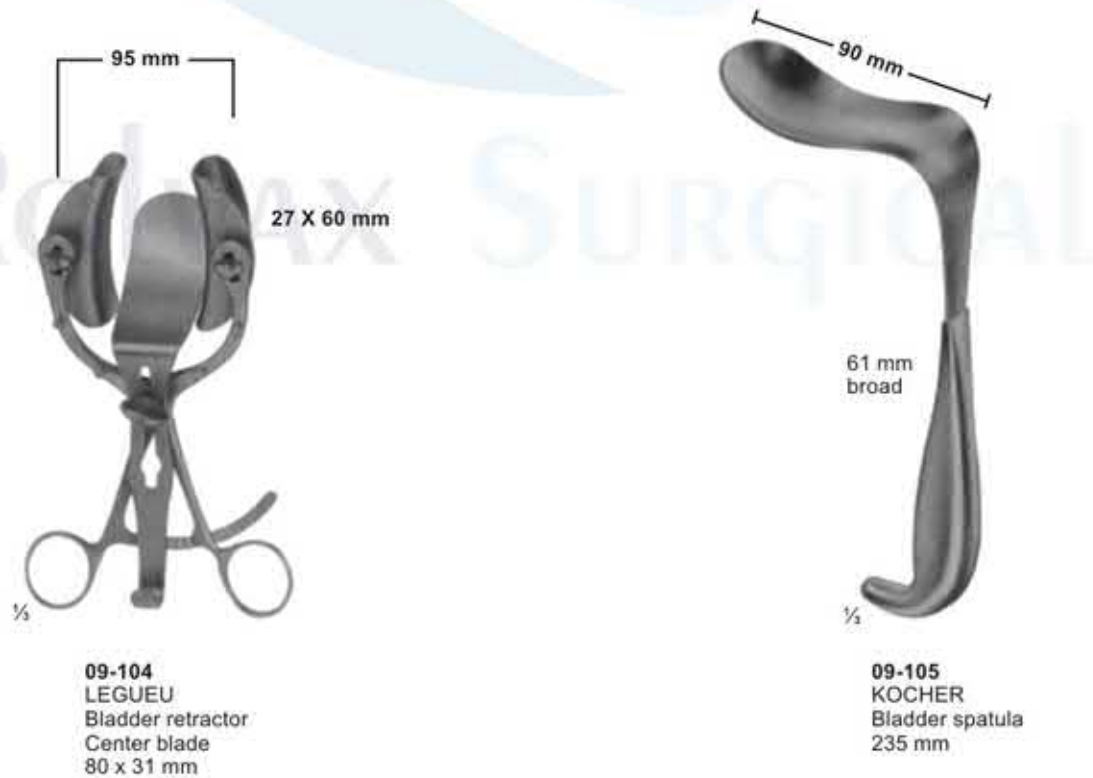

Trocars



Luer Lock

09-106
KLIMA ROSEGER
35 X 1,8 mm
Sternal puncture needle

09-107
Universal trocar
with 4 tips

∅ 6,0 mm
∅ 4,5 mm
∅ 3,3 mm
∅ 1,9 mm

NELSON

09-108 - 112
Inside diam. Outside diam
09-108 2,2 mm 3,0 mm
09-109 3,0 mm 4,0 mm
09-110 4,0 mm 5,0 mm
09-111 5,0 mm 6,0 mm
09-112 5,5 mm 6,5 mm
for hydrocele and abdominal puncture

09-113 - 116
Inside dime. Outside dime
09-113 2,2 mm 3,0 mm
09-114 3,0 mm 4,0 mm
09-115 4,0 mm 5,0 mm
09-116 5,0 mm 6,0 mm
for abdominal puncture,
with stop-cock and lateral
drain

100 mm
110 mm

100 mm

Record Cone1

Luer - Lock
Cone

09-117 - 118
Inside diam. Outside diam
09-117 6,5 mm 8,0 mm
09-118 9,0 mm 10,0 mm
Empyema trocar
BUELEU

09-119 - 122
Inside diam. Outside diam
09-119 3,0 mm 4,0 mm
09-120 3,6 mm 4,6 mm
09-121 4,3 mm 5,3 mm
09-122 5,0 mm 6,0 mm
Gall bladder trocars. OCHSNER

09-123
PIERCE
Antrum trocar
∅ 4,0 mm

09-124
COAKLEY
Antrum trocar
3,0 mm

Vaginal Specula



10-101
COLLIN
for children
53 x 10 mm

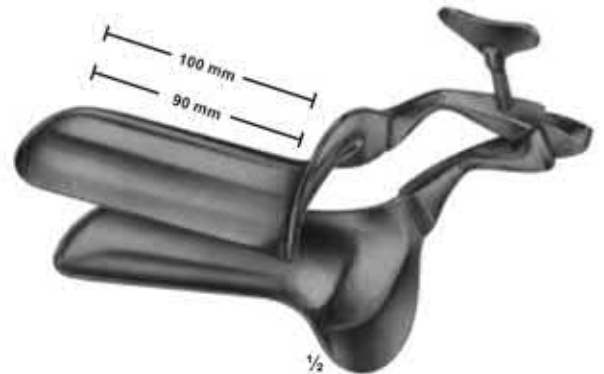

10-102 - 105
COLLIN
10-102 100/90mm 28 mm
10-103 100/90mm 32 mm
10-104 105/95mm 35 mm
10-105 115/105mm 40 mm
Total length/working length width



10-106
COLLIN
for virgins
95/85 x 18 mm



10-107
CUSCO
for virgins
75 x 17 mm



10-108
CUSCO
for virgins
75 x 17 mm



Swiss patterns
features: long and narrow

10-109 - 111
CUSCO
10-109 92X23-25 mm
10-110 100x25-27 mm
10-111 110x27-30 mm

Vaginal Specula- Sets, upper and lower blades



10-112 - 114
GRAVE
 10-112 75X20 mm
 10-113 95X30 mm
 10-114 105X33 mm

½



10-115 - 116
PEDERSON
 10-115 100X22 mm
 10-116 120X25 mm

½



10-117 - 118
BRIESKY
 10-117 72X25 mm / 77X30 mm 140 mm
 10-118 75X30 mm / 92X38 mm 170 mm

½



10-119
SIMS
 70 X 26 mm / 75 X 30 mm
 75 X 30 mm / 80 X 35 mm
 80 X 36 mm / 90 X 40 mm
 175 mm

½



10-120 - 122
SEIDL
 10-120 80X8 mm
 10-121 80X10 mm
 10-122 90X14 mm
 For children and infants
 170 mm

½



10-123
KRISTELLER
 70X15 mm, (170 mm)
 For children

½



10-124 - 10-126
KRISTELLER
 10-124 70X27 mm
 10-125 75X30 mm
 10-126 90X36 mm
 175 mm

½

Vaginal Specula- upper and lower blades



10-127 - 131
KRISTELLER
10-127 110X18 mm
10-128 110X20 mm
10-129 110X27 mm
10-130 110X30 mm
10-131 110X36 mm
220 mm

10-132 - 10-135
KRISTELLER
Upper blades

10-136 - 10-139
KRISTELLER
Lower blades

Vaginal Specula



10-140
60 X 45 mm

10-141
90 X 45 mm

10-142
112 X 45 mm

10-140 - 142
DOYEN
235 mm

10-143 - 10-153
DOYEN
240 mm

width of blades		width of blades	
35 mm	45 mm	60 mm	
60 mm	10-143	10-146	10-150
90 mm	10-144	10-147	10-151
120 mm	10-145	10-148	10-152
160 mm		10-149	10-153

Vaginal Retractors



½
10-154
JOLL (FRIEDMAN)
155 mm



½
10-155
RICHTER
170 mm

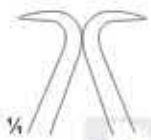

½
10-156
GELPI
135 mm

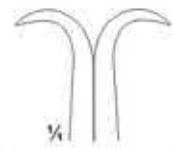

½
10-157
GELPI
175 mm

Uterine Dilators



11-101 - 143
HEGAR
with very conical point
185 mm

11-101	1	mm	11-123	23	mm
11-102	2	mm	11-124	24	mm
11-103	3	mm	11-125	25	mm
11-104	4	mm	11-126	26	mm
11-105	5	mm	11-127	1	1/2mm
11-106	6	mm	11-128	2	1/2mm
11-107	7	mm	11-129	3	1/2mm
11-108	8	mm	11-130	4	1/2mm
11-109	9	mm	11-131	5	1/2mm
11-110	10	mm	11-132	6	1/2mm
11-111	11	mm	11-133	7	1/2mm
11-112	12	mm	11-134	8	1/2mm
11-113	13	mm	11-135	9	1/2mm
11-114	14	mm	11-136	10	1/2mm
11-115	15	mm	11-137	11	1/2mm
11-116	16	mm	11-138	12	1/2mm
11-117	17	mm	11-139	13	1/2mm
11-118	18	mm	11-140	14	1/2mm
11-119	19	mm	11-141	15	1/2mm
11-120	20	mm	11-142	16	1/2mm
11-121	21	mm	11-143	17	1/2mm
11-122	22	mm			



11-144 - 152
HEGAR
205 mm

11-144	1+2	mm
11-145	3+4	mm
11-146	5+6	mm
11-147	7+8	mm
11-148	9+10	mm
11-149	11+12	mm
11-150	13+14	mm
11-151	15+16	mm
11-152	17+18	mm



11-153
HEGAR
Uterine dilator set, in canvas
roll with 8 dilators.

Uterine Probes



Uterine Dressing Forceps



Jaws with longitudinal groove

Polypus-and Ovum Forceps



11-164
HEYWOOD-SMITH
200 mm

11-165
KELLY
320 mm

11-166
HEYWOOD-SMITH
250 mm

11-167
NOTO
280 mm

Ear Currettes

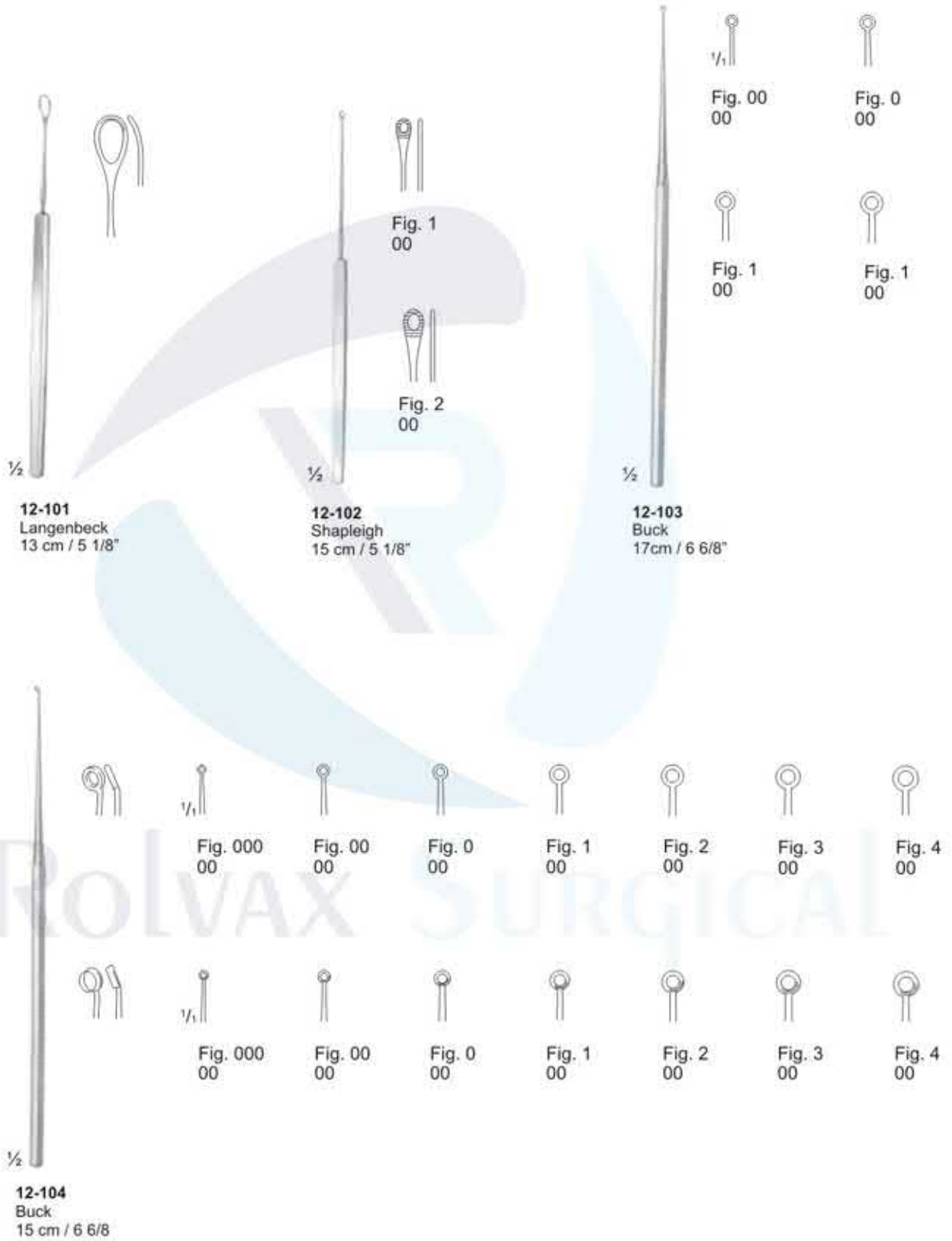

Biopsy Currettes



12-105
ASCH
Uterine
Secretion scoop
200 mm

12-106
Uterine
Secretion scoop
270 mm

12-107
NOVAK-SCHOECKAERT
Endometrial biopsy
curette
240 mm

12-108
RANDALL
Endometrial
biopsy curette
240 mm

Ear Polypus Forceps



12-109
Hartmann-Wullstein
shaft length
85 mm



12-110
Hartmann-Wullstein
shaft length
85 mm



12-111
Hartmann
shaft length
85 mm



12-112
Hartmann
shaft length
85 mm

1/4

12-113
14 cm / 5 4/8"
shaft length
140 mm

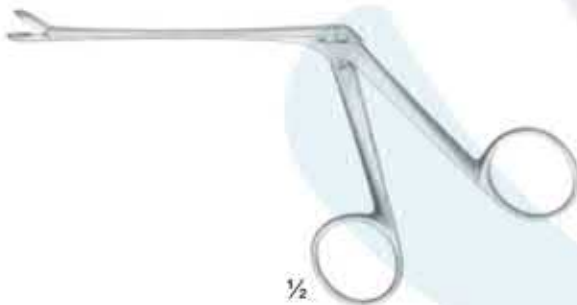

1/2

12-109 - 12-119

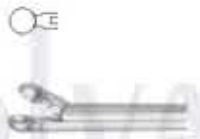

12-114
Hartmann-Herzfelr
2,0 mm
shaft length
85mm



12-115
Hartmann
3 mm
shaft length
85mm



12-116
shaft length
85mm



12-117
Hartmann-Hoffmar
2,0 mm
85mm

12-118
2,5 mm
85 mm

12-119
3,0 mm
85 mm

Biopsy forceps for rectum

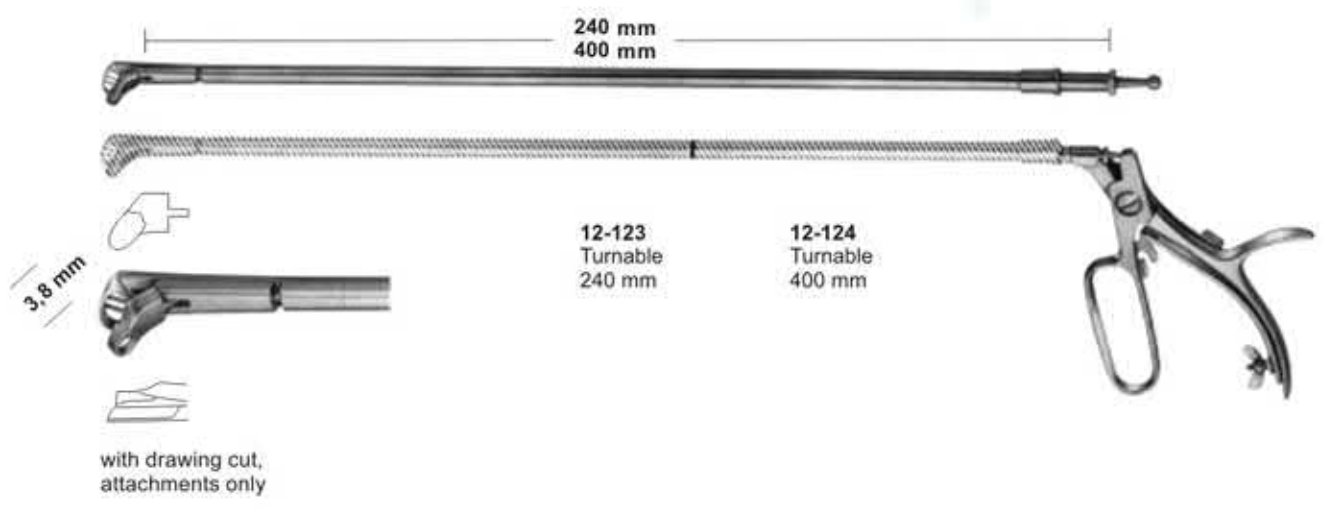

Biopsy Forceps



Biopsy Forceps



Uterine Scoops



Obstetrical Forceps



1/2

13-101
NAEGELE
355 mm



1/2

13-102
NAEGELE
400 mm



1/2

13-103
SIMPSON-BRAUN
305mm

Obstetrics- Placenta and Ovum Forceps



13-104 - 106
WINTER
290 mm

13-107 - 109
WINTER
290 mm

13-110
SAENGER
275 mm

Tound-and Tracheal Hooks and Dilators



13-111
BOSE
165 mm



13-112
BOSE
165 mm



13-113 - 115
180 mm



13-114
blunt



13-115
stumpf/blunt



13-116
FINSEN
50 mm



13-117
FINSEN
70 mm



13-118
TROUSSEAU
120 mm



13-119
LABORDE
125 mm



13-120
LABORDE
strong pattern
135 mm



13-121
Cleaning Brush
for tracheal tubes
285 mm

Vascular Spatulas



**ATRAUMATA
Forceps**



14-111 - 112
DE BAKEY
150 mm
200 mm



14-111 1,5 mm
14-112 1,5 mm



14-113 - 116
DE BAKEY



14-113 2 mm 150 mm
14-114 2 mm 200 mm
14-115 2 mm 240 mm
14-116 2 mm 300 mm



14-117 - 120
DE BAKEY

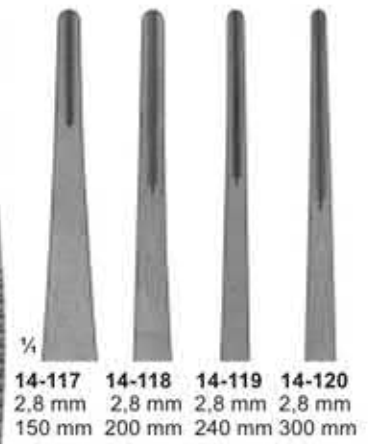

14-117 2,8 mm 150 mm
14-118 2,8 mm 200 mm
14-119 2,8 mm 240 mm
14-120 2,8 mm 300 mm



14-121 - 123
DE BAKEY



14-121 3,3 mm 200 mm
14-122 3,5 mm 300 mm
14-123 3,5 mm 240 mm



14-124
DE BAKEY
150 mm



14-124
2 mm



14-125
DE BAKEY
200 mm



14-125
2 mm

ATRAUMATA
Anastomosis- and Multi- Purpose-
Clamps- Pediatric types

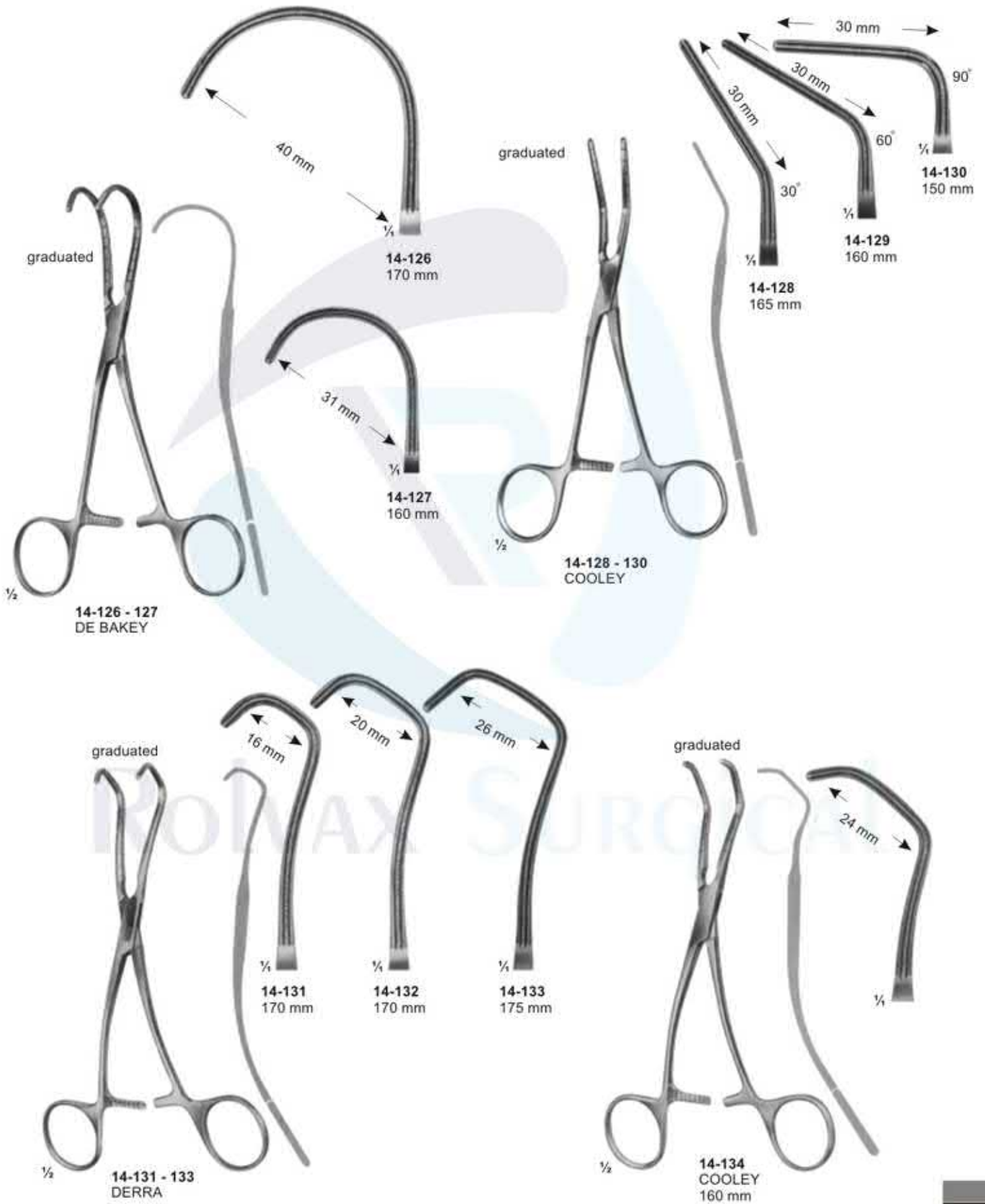

ATRAUMATA
Coarctation Clamps, Patent-Ductus &
Peripheral-Vascular Clamps



Aorta- Anastomosis Clamps

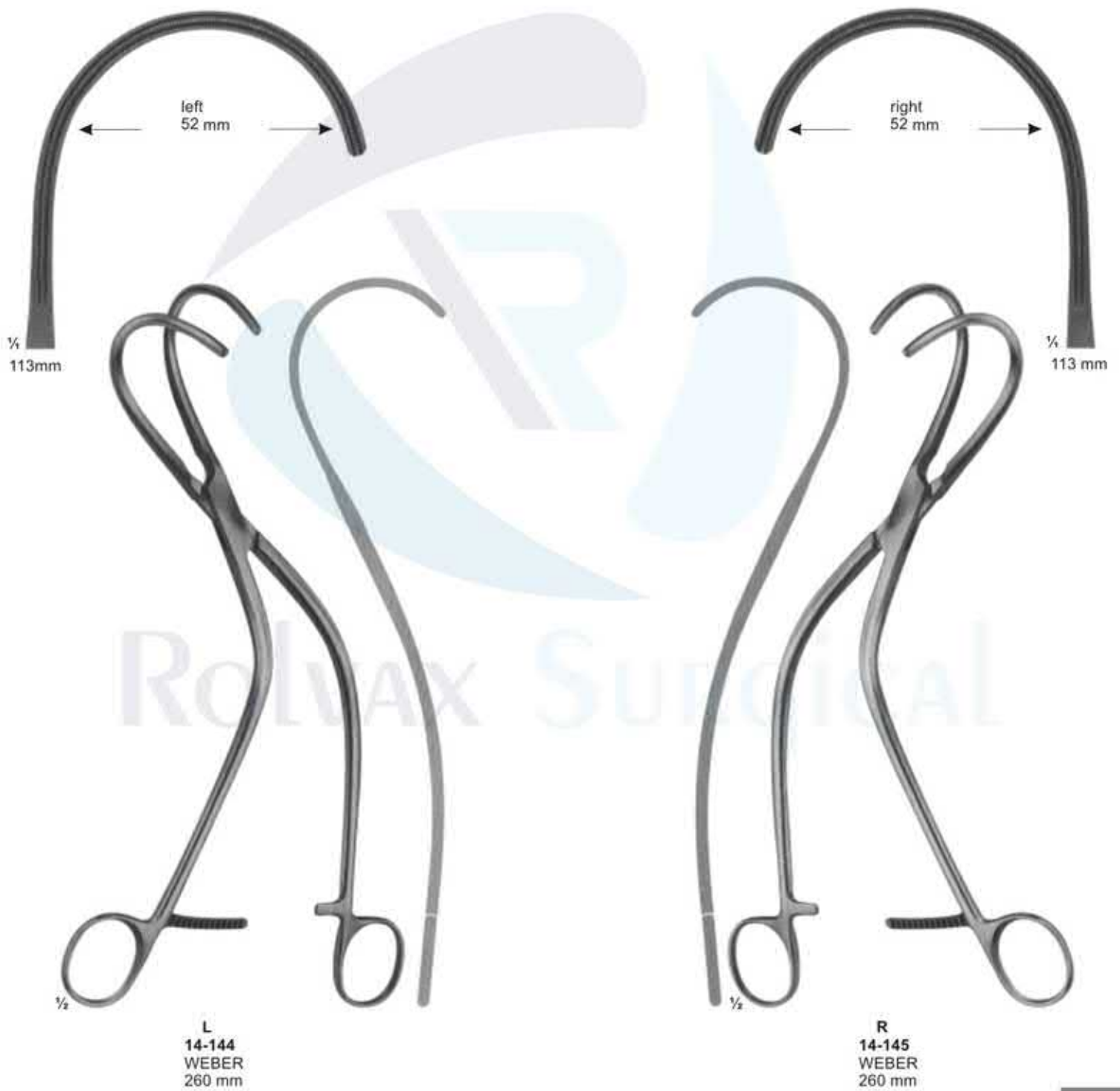

Multi- Purpose-Clamps



14-146 - 149
DE BAKEY



14-146 **14-147** **14-148** **14-149**

Total Length:	230 mm	280 mm	305 mm	240 mm
Length of jaws:	85 mm	100 mm	135 mm	93 mm



14-150 - 153
DE BAKEY



14-150 **14-151** **14-152** **14-153**

Total Length:	225 mm	210 mm	275 mm	255 mm
Length of jaws:	93 mm	85 mm	134 mm	92 mm

Sternum Instruments and Rib Shears



14-154
SCHUMACHER
Sternum shears
210 mm



14-155
LEBSCHKE
Sternum chisel
200 mm



14-156
230 mm



14-157
COLLIN
195 mm



14-158
GLUCK
190 mm



14-159
BETHUNE
340 mm



14-160
BRUNNER
Universal pattern
340 mm



14-161
GIERTZ-STILLE
250 mm

Rib Spreaders



14-162
FINOCHIETTO
Blades
18X21 mm



14-163
HERTZLER
Blades
20X25 mm



14-164
TUFFIER
Blades
43X53 mm



14-165
FINOCHIETTO
Blades
36X45 mm

Rib Spreaders-and Contractors



14-166
SELLORS
Rib spreader-and contractor
with swivel blades
200 mm



14-167
BAILEY
150 mm



14-168
for children

14-169
for adults

14-168 - 169
BAILEY
200 mm

Punches

130° upwards cutting

15-101
1 mm
KERRISON - JACOBY

FERRIS-SMITH-KERRISON

15-102
2 mm

15-103
3 mm

15-104
4 mm

15-105
5 mm

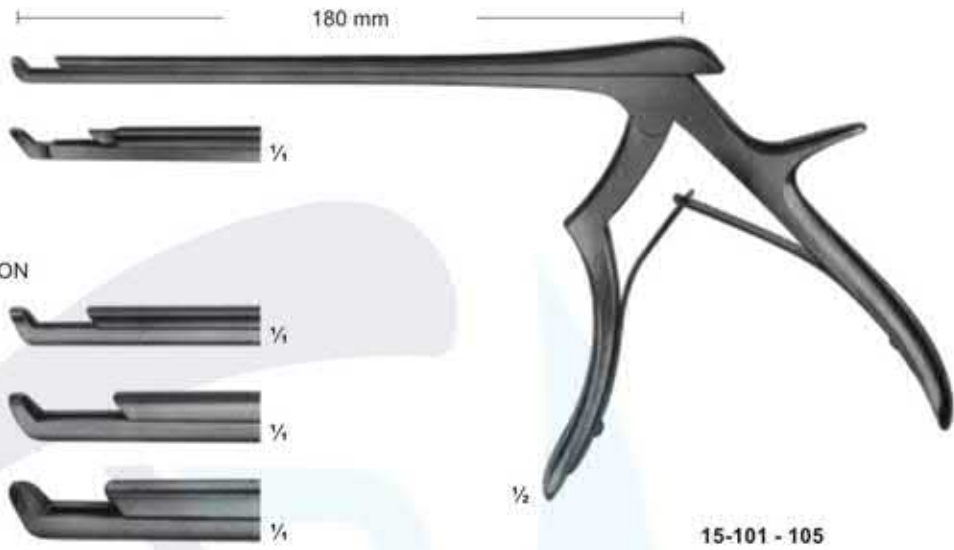

90° upwards cutting

KERRISON - JACOBY

15-106
1 mm

15-107
2 mm

FERRIS-SMITH-KERRISON

15-108
3 mm

15-109
4 mm

15-110
5 mm

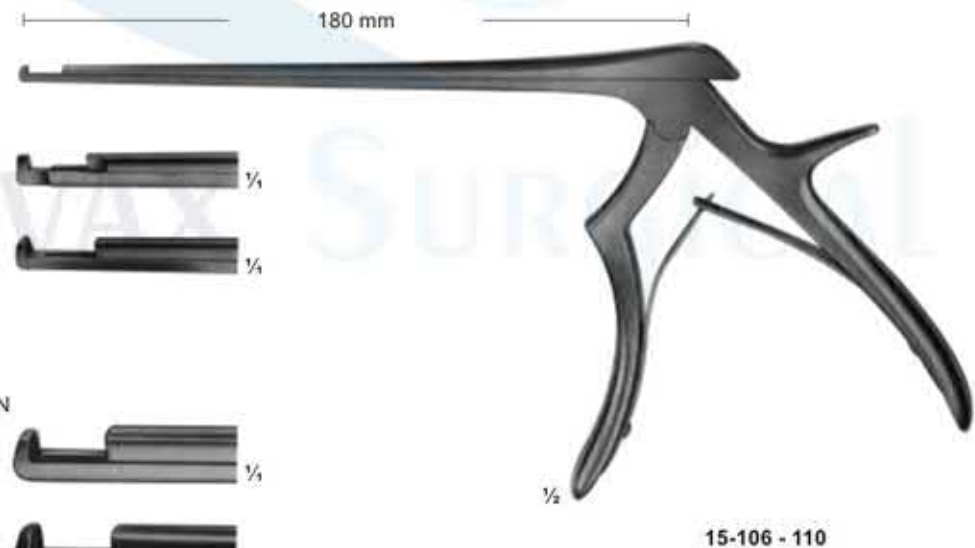

Punches

90° upwards cutting



15-111
4 mm



1/4

15-112
5 mm



1/4

15-111 - 15-112
KERRISON

90° upwards cutting



15-113
3,3 mm



1/4

15-114
4,0 mm



1/4

15-113 - 15-114
HAJEK-KOFLER

Rongeurs

LOVE-GRUENWALD

15-115
2 X 10 mm



15-116
3 X 10 mm



SPURLING

15-117
4 X 10 mm



130 mm



15-115 - 15-117

15-118
2 mm



15-119
3 mm



15-120
4 mm



15-121
5 mm



155 mm



15-118 - 15-121
CASPAR

150°

15-122
2 mm



15-123
3 mm

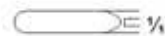

15-124
4 mm



155 mm



15-122 - 15-124
CASPAR

Rongeurs

Angled positions for rongeurs

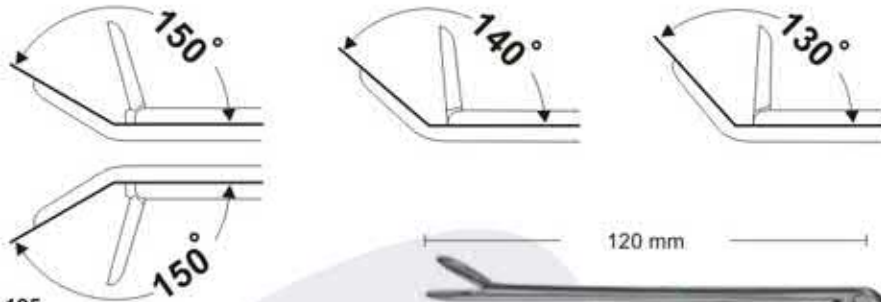

- 15-125
3,0 mm
- 15-126
3,6 mm
- 15-127
4,2 mm
- 15-128
4,8 mm
- 15-129
5,8 mm

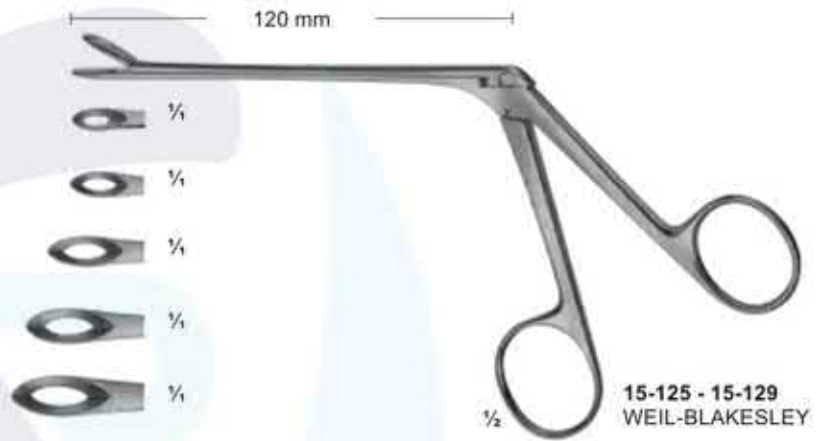

130°

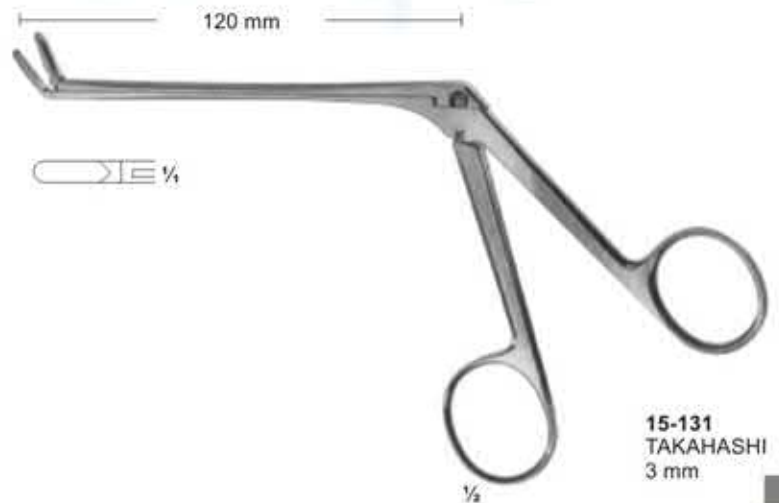

Rongeurs

150°

Lower part of jaws movable

15-132
2 mm



15-133
3 mm

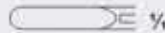

15-134
4 mm



15-132 - 15-134
CASPAR

Length of shaft 140 mm	Length of shaft 160 mm	Length of shaft 185 mm	size of jaws
15-135	15-140	15-145	2 X12 mm
15-136	15-141	15-146	3 X12 mm
15-137	15-142	15-147	4 X14 mm
15-138	15-143	15-148	5 X14 mm
15-139	15-144	15-149	6 X16 mm



15-135 - 15-149
CASPAR

150°

Length of shaft 140 mm	Length of shaft 160 mm	Length of shaft 185 mm	size of jaws
15-150	15-153	15-156	3 X12 mm
15-151	15-154	15-157	4 X14 mm
15-152	15-155	15-158	5 X14 mm



15-150 - 15-158
CASPAR

Rongeurs

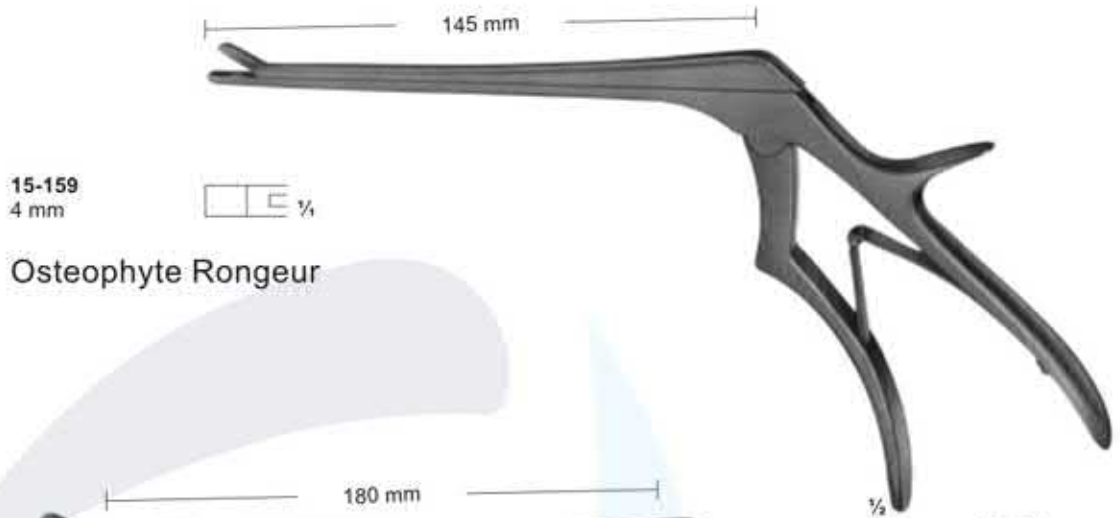

15-159
CASPAR



15-160
CASPAR

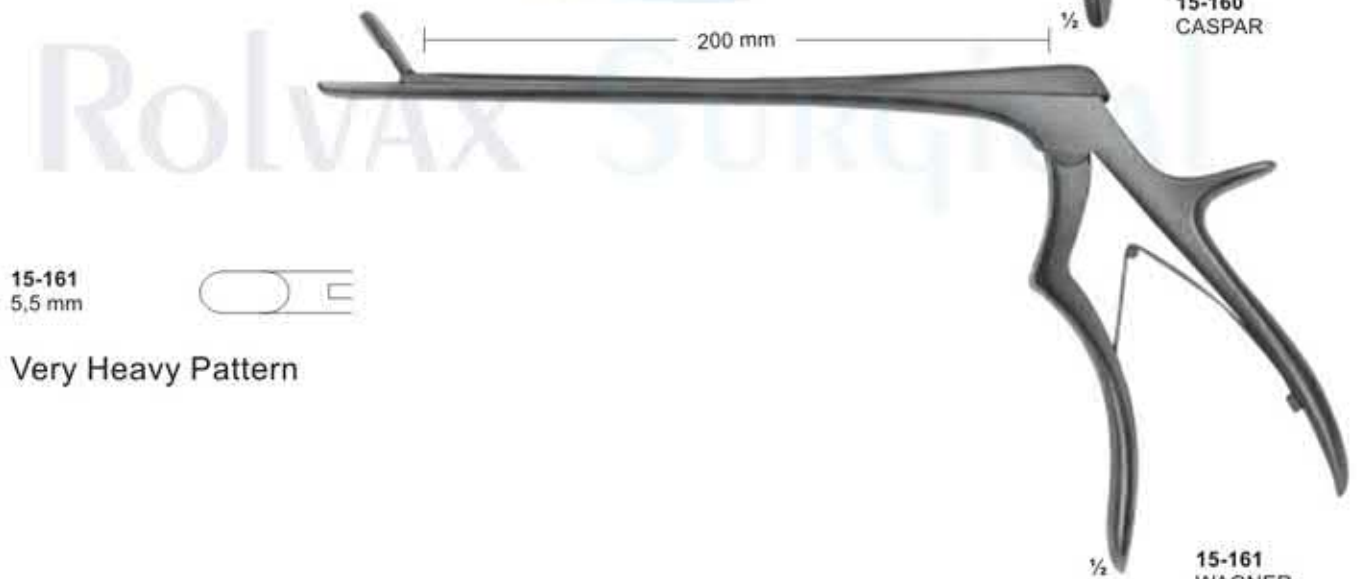

15-161
WAGNER

Elevators and Bone Levers



Bone Levers



16-109
LANE TRETHOWAN
215mm

16-110
LANE
255mm

16-111
LANGE-HOHMANN
250mm

16-112 - 113
LANGE-HOHMANN modif.
16-112 265mm
16-113 280mm

Raspatories

3,2 mm 4,6 mm



16-114 16-115



16-114
PARTSCH
150 mm

4 mm



16-116
PARTSCH mod. LANGE
145 mm

4,4 mm



16-117
MC KENTY
155 mm

5 mm



16-118
KOENIG
155 mm

8 mm



16-119
TRELAT
150 mm

4,2 mm



16-120
WILLIGER
140 mm

6 mm



16-121
WILLIGER
160 mm

4 mm

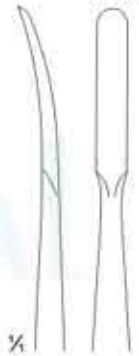

16-122
JOSEPH
170 mm

Bone File and Rasps

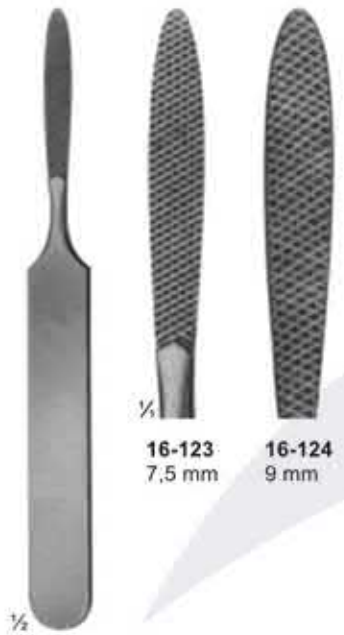

16-123
JOSEPH
fine, chequered
16-124
coarse, chequered
165 mm

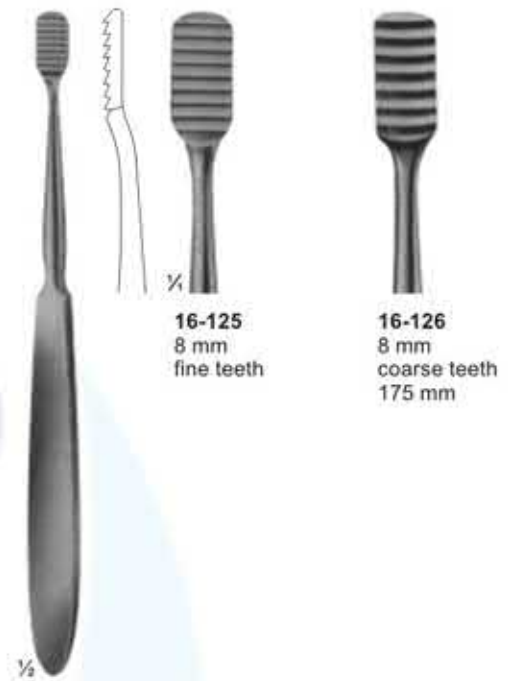

16-125
8 mm
fine teeth
16-126
8 mm
coarse teeth
175 mm



16-127
MALTZ
down stroke
180 mm



16-128 - 16-129
AUFRICHT
up stroke
16-129
down stroke
220 mm



16-130
GALLAHER
190 mm

Bone Currettes



16-131
JACOBSON
140 mm



16-132
MARTINI
140 mm



16-133
MARTINI
140 mm



16-134
WILLIGER
145 mm



16-135
JANSEN
160 mm



16-136
BARTH
180 mm



16-137
VOLKMANN
130 mm

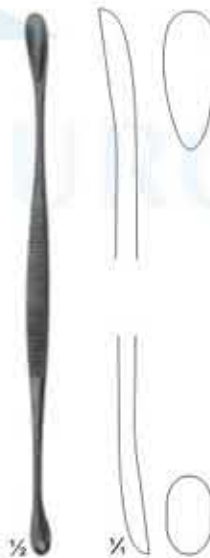

16-138
VOLKMANN
145 mm



16-139
VOLKMANN
170 mm

Mallets Weights refer to the heads of the mallets
Hammer Die Gewichtsangaben beziehen sich auf den Kopf des jeweiligen Hammers



∅ 20 mm

½

17-101
MEAD
 185 g
 with interchangeable
 plastic disks
 190 mm
17-102
 pair of spare disks



∅ 25 mm

½

17-103
 140 g
 with interchangeable
 plastic disks
 185 mm
17-104
 pair of spare disks



∅ 30 mm

½

17-105
COTTLE
 140 g
 1 Side Flat
 1 Side convex
 185 mm



∅ 22 mm

½

17-106
 165 g
 lead filled head
 190 mm

Osteotomes, Chisels and Gouges



17-107
MANNERFELT
Gouge
155 mm



17-108 - 112
Osteotomes
140 mm

- | | |
|---------------|-------|
| 17-108 | 4 mm |
| 17-109 | 6 mm |
| 17-110 | 8 mm |
| 17-111 | 10 mm |
| 17-112 | 12 mm |



17-113 - 117
Chisels
140 mm

- | | |
|---------------|-------|
| 17-113 | 4 mm |
| 17-114 | 6 mm |
| 17-115 | 8 mm |
| 17-116 | 10 mm |
| 17-117 | 12 mm |



17-118 - 122
Gouges
140 mm

- | | |
|---------------|-------|
| 17-118 | 4 mm |
| 17-119 | 6 mm |
| 17-120 | 8 mm |
| 17-121 | 10 mm |
| 17-122 | 12 mm |



17-123 - 126
Chisels
140 mm

- | | |
|---------------|------|
| 17-123 | 3 mm |
| 17-124 | 4 mm |
| 17-125 | 5 mm |
| 17-126 | 6 mm |



17-127 - 131
Chisels
170 mm

- | | |
|---------------|------|
| 17-127 | 3 mm |
| 17-128 | 4 mm |
| 17-129 | 5 mm |
| 17-130 | 6 mm |
| 17-131 | 7 mm |



17-132 - 135
Gouges
140 mm

- | | |
|---------------|------|
| 17-132 | 3 mm |
| 17-133 | 4 mm |
| 17-134 | 5 mm |
| 17-135 | 6 mm |



17-136 - 140
Gouges
170 mm

- | | |
|---------------|------|
| 17-136 | 3 mm |
| 17-137 | 4 mm |
| 17-138 | 5 mm |
| 17-139 | 6 mm |
| 17-140 | 7 mm |



17-141 - 142
Chisels
160 mm

- | | |
|---------------|------|
| 17-141 | 4 mm |
| 17-142 | 6 mm |

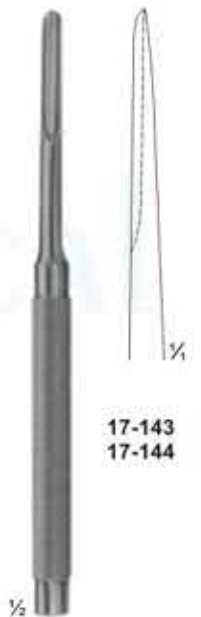

17-143 - 144
Gouges
160 mm

- | | |
|---------------|------|
| 17-143 | 3 mm |
| 17-144 | 5 mm |

Reposition Forceps, Bone Holding Forceps



17-145
Patella forceps
185 mm



17-146
Forceps with
ratchet fixation
140 mm



17-147
Forceps with
thread fixation
170 mm



17-148
Forceps with
thread fixation
235 mm



17-149
DINGMANN
185 mm

Bone Holding Forceps & Bone Clamps



Bone Rongeurs



17-158
LUER
150 mm



17-159
LUER
155 mm



17-160
BLUMENTHAL
155 mm



17-161
BLUMENTHAL
150 mm



17-162 - 163
JANSEN
175 mm



17-164
BANE-HARTMANN
175 mm

Bone Rongeurs



17-165
STILLE
235 mm



17-166
LEKSELL-STILLE
240mm



17-167
STILLE-RUSKIN
240mm

Bone Cutting Forceps



17-168
LISTON
curved on flat
240 mm

17-169
LISTON
straight
280 mm

17-170
LISTON
curved on flat
280 mm

Wire Extension

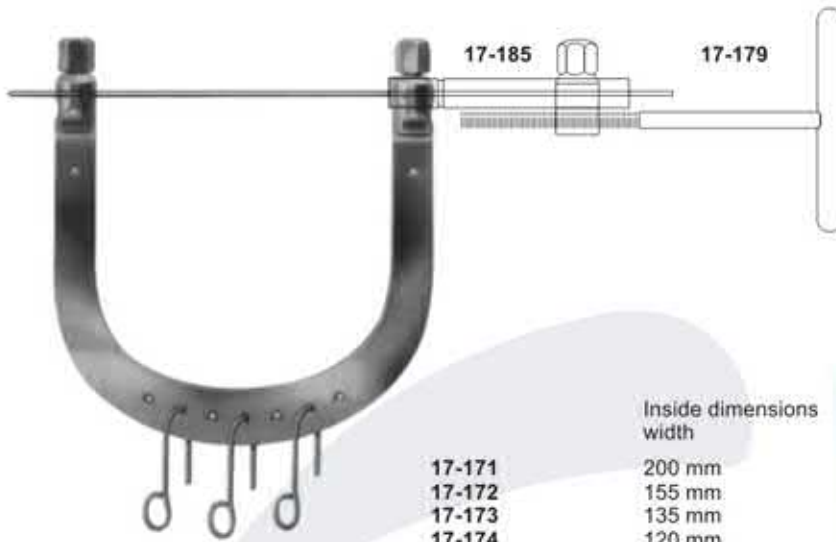

17-171 - 17-177
KIRSCHNER
 Wire traction bows,
 to be used with
 KIRSCHNER-wires
 up to 2.5 mm diam.,
 With 3 hooks,
 stainless steel

	Inside dimensions width	depth	
17-171	200 mm	155 mm	for the hip
17-172	155 mm	155 mm	for the femur
17-173	135 mm	130 mm	for the knee
17-174	120 mm	120 mm	for the knee
17-175	105 mm	100 mm	for the knee
17-176	95 mm	110 mm	for the calcaneus
17-177	95 mm	70 mm	for the arm and elbow



17-178
 Wrench, double - ended,
 for wire traction bows



17-179
 Wire tightener, with
 clamping jaws



17-182	max. 105 mm
17-183	max. 160 mm
17-184	max. 200 mm
17-182	80-95 mm
17-183	90-120 mm
17-184	140-170 mm
diam upto	
17-182	1,6 mm
17-183	2,0 mm
17-184	2,5 mm

17-182 - 17-184
KIRSCHNER
 Wire traction bows, modified,
 adjustable in width, holds wire
 securely, with 1 hook



17-180
 Traction hook only,
 large size



17-181
 Traction hook only,
 small size



17-185
 Fixation clamp, to secure clamping
 jaws of 17-179 stainless steel

Cerclage Instruments

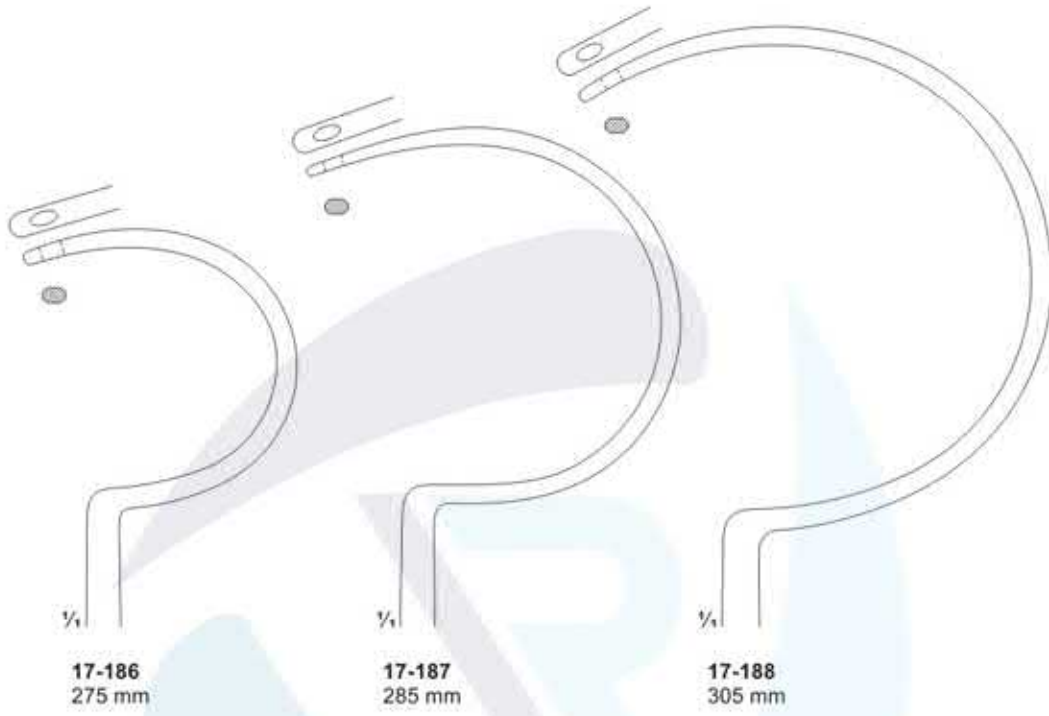

17-186 - 17-188
DEMEL
Wire guides



Wire Holding forceps, Wire Tightening Pliers, Flat-nosed Pliers DUROGRIP with Hard Metal Inserts



17-192
DUROGRIP
Holding forceps for cerclage wire, with lateral jaws to avoid wire slipping off
170 mm



17-193
DUROGRIP
Wire, tightening pliers, Ligature pliers
150 mm



17-194
DUROGRIP
Wire, tightening pliers, Ligature pliers
150 mm



17-195
with serrated jaws
140 mm



17-196
one jaw smooth, one jaw serrated
140 mm



17-197
with serrated jaws
17-198
with longitudinal and transversal grooves
170 mm



17-199
190 mm

Wire Holding forceps, Flat-nosed Pliers, Pliers for bending and cutting wires

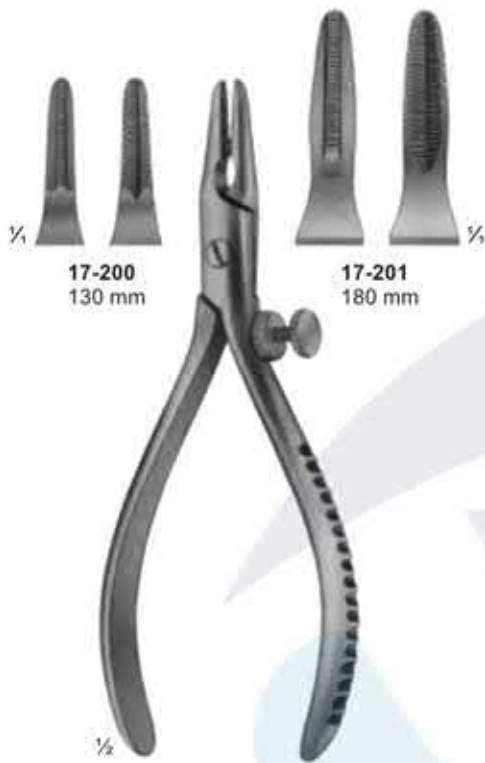

17-200
130 mm

17-201
180 mm

17-200 - 17-201
Extraction pliers
for boring wires



17-202
Flat-nosed pliers,
parallel
185 mm

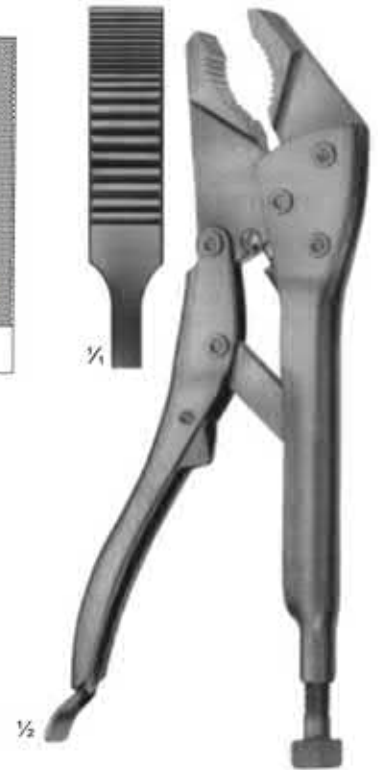

17-203
Vise grip
200 mm



17-204
Round Pliers
180mm

17-204 - 17-207

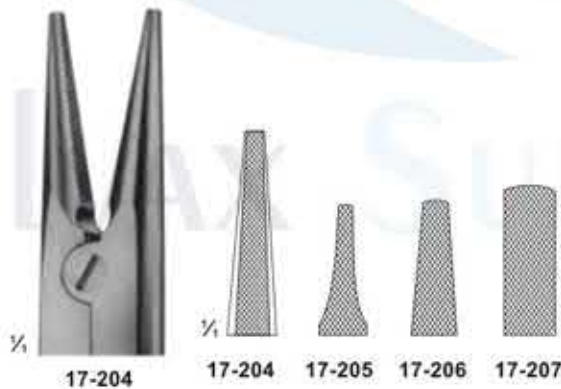

17-204

17-204

17-205

17-206

17-207

17-205 145 mm
17-206 180 mm
17-207 180 mm
Extraction pliers for wires



17-208
Bending pliers
for wires up to
1.8 mm diam.

Wire Cutters and wire Cutting Scissors DUROTIP with Carbide Cutting Edges



**17-209
ANGLE**
130 mm

for soft wire
up to diam. 0,5 mm
for hard wire
up to diam. 0,3 mm



**17-211 17-212
DUROTIP**
120 mm

for soft wire
up to diam. 1,2 mm
for hard wire
up to diam. 0,8 mm



**17-213
HARVEY**
125 mm

0,4 mm
0,3 mm



17-214
150 mm

for soft wire
up to diam 1,5 mm
for hard wire
up to diam 1,0 mm



17-215
160 mm

1,5 mm
1,2 mm



17-216
140 mm
DUROTIP

1,5 mm
1,0 mm

Wire Cutting Pliers, Lateral Cutting Action



for soft wire
up to diam. 2,0 mm
For hard wire 1,5 mm
up to diam
specially hardened
cutting edges, front
and lateral cutting
action

for soft wire
up to diam. 2,0 mm
For hard wire 1,6 mm
up to diam
specially hardened
cutting edges, for
cutting off wires close
to the bone

for soft wire
up to diam. 3,0 mm
For hard wire 2,2 mm
up to diam

Wire Cutting Pliers, Lateral and Front Cutting Action



Wire Cutting Pliers



17-224
320 mm

for soft wire
up to diam. 3,0 mm
For hard wire
up to diam 3,0 mm



Cutter for cutting off
KIRSCHNER wires,
Tibia head screws,
bolts, pins, up to 3 mm diam.



DUROTIP

17-225
Cutter for cutting off
KIRSCHNER wires,
Tibia head screws,
bolts, pins, up to 6 mm diam.
470 mm

Finger Nail Instruments



17-226
Nail extracting
forceps
135 mm



17-227
Nail extracting
forceps
145 mm



17-228
Finger nail drill
with 3 drill points

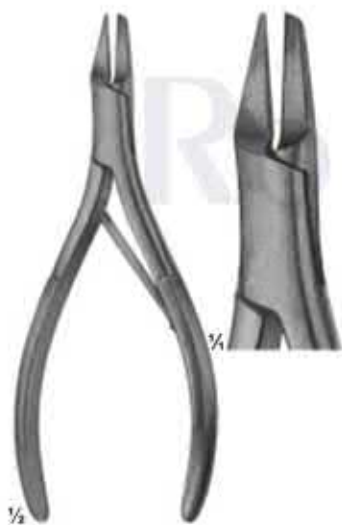

17-231
Nail splitting
forceps
135 mm



17-232
SYSTRUNK
Scissors, for splitting
finger nails
130 mm



17-233
Finger ring saw
150 mm

Plaster Shears



17-235
STILLE-AESCULAP
260 mm

17-236
STILLE-AESCULAP
360 mm

Plaster Spreader, Plaster Breakers



17-237
HENING
270 mm



17-238
MOD. USA
230 mm



17-239
290 mm



with removable jaws



17-240 - 17-241
WOLFF
17-240 180 mm
17-241 240 mm
plaster breakers

Vacuum Curettes for Aspiration Lipectomy, Suction Instruments



18-101 - 18-106
BIEMER

18-101 \varnothing 4 mm
 18-102 \varnothing 6 mm
 18-103 \varnothing 8 mm
 18-104 \varnothing 10 mm
 18-105 \varnothing 12 mm
 18-106 \varnothing 14 mm
 Curettes for aspiration lipectomy, graduated, slightly curved

18-107 - 18-108
BIEMER

18-107 \varnothing 4 mm
 18-108 \varnothing 6 mm
 Curettes for aspiration lipectomy, with three apertures, slightly curved malleable

18-109 - 18-111
BIEMER

18-109 \varnothing 8 mm
 18-110 \varnothing 10 mm
 18-111 \varnothing 12 mm
 Curettes for aspiration lipectomy, with three apertures, slightly curved malleable

18-112
 For aspirating fluid from the excretory ducts of large glands and for keeping the operating area clear
 170 mm

18-113
Trocar
 For puncturing
 150 mm

18-114
 For clearing large quantities of fluid
 190 mm

Suction Instruments

18-115 150mm
Suction handle, with vacuum regulator and finger cut-off, brass, mirror-finish chromium-plated



olive
Ø 9 mm

18-116 170mm
Suction handle, with hand regulation valve and quick-shutter, brass, mirror-finish chromium-plated



Both suction handles have bayonet fitting Olive and can be used for the suction cannulae. Ø 9 mm



18-117
Trocar
For puncturing
170 mm



18-118
Hollow needle,
sharp
150 mm



18-119
double curved
For general
surgery
230 mm



18-120
For tonsillectomy,
oral and laryngeal
operations
190 mm



18-121
For tonsillectomy,
oral and laryngeal
operations
220 mm

★ With bayonet fitting to be used with suction handles (18-115 - 18-116)

Suction Instruments

18-122
WULLSTEIN
 Suction tube, conical, silver, olive
 with LUER hub
 160 mm



18-123 1,5 mm
18-124 2,0 mm
WULLSTEIN
 Suction tube, cylindrical, silver, with
 stylet olive with LUER hub
 160 mm



Usable length

YASARGIL usable length diam.		YASARGIL usable length diam.	
18-125	130 mm 1,5 mm	18-133	130 mm 2,5 mm
18-126	150 mm 1,5 mm	18-134	150 mm 2,5 mm
18-127	180 mm 1,5 mm	18-135	180 mm 2,5 mm
18-128	220 mm 1,5 mm	18-136	220 mm 2,5 mm
18-129	130 mm 2,0 mm	18-137	130 mm 3,5 mm
18-130	150 mm 2,0 mm	18-138	150 mm 3,5 mm
18-131	180 mm 2,0 mm	18-139	180 mm 3,5 mm
18-132	220 mm 2,0 mm	18-140	220 mm 3,5 mm
		18-141	180 mm 4,5 mm

18-142 - 18-144
LANDOLT
 150 MM
 diam $\varnothing 3 \text{ mm}$

18-142 8 mm / curved
18-143 11mm / curved
18-144 15mm / curved

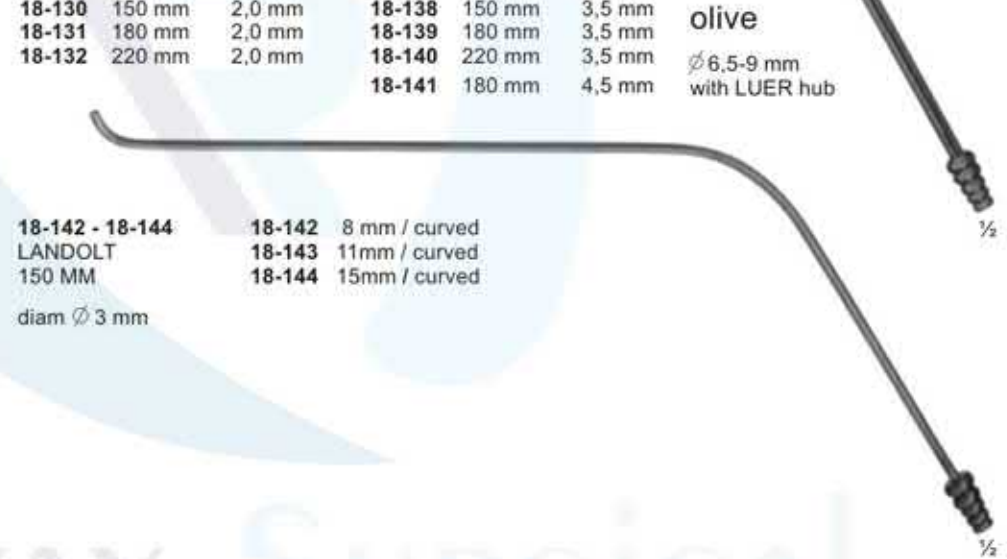

$\varnothing 3,5 \text{ mm}$

$\varnothing 2,0 \text{ mm}$

18-145 500 mm
18-146 350 mm
 with rubber tip,
 with LUER hub

olive $\varnothing 9 \text{ mm}$
 $\frac{1}{2}$

18-147 2,0 mm diam
18-148 2,5 mm diam
18-149 3,0 mm diam
 with finger cut-off,
 thumb piece 90° to
 curve, with LUER hub
 250 mm

olive $\varnothing 6-9 \text{ mm}$
 $\frac{1}{2}$

Combined Suction and Irrigation Cannulae, Coagulation Suction Cannulae

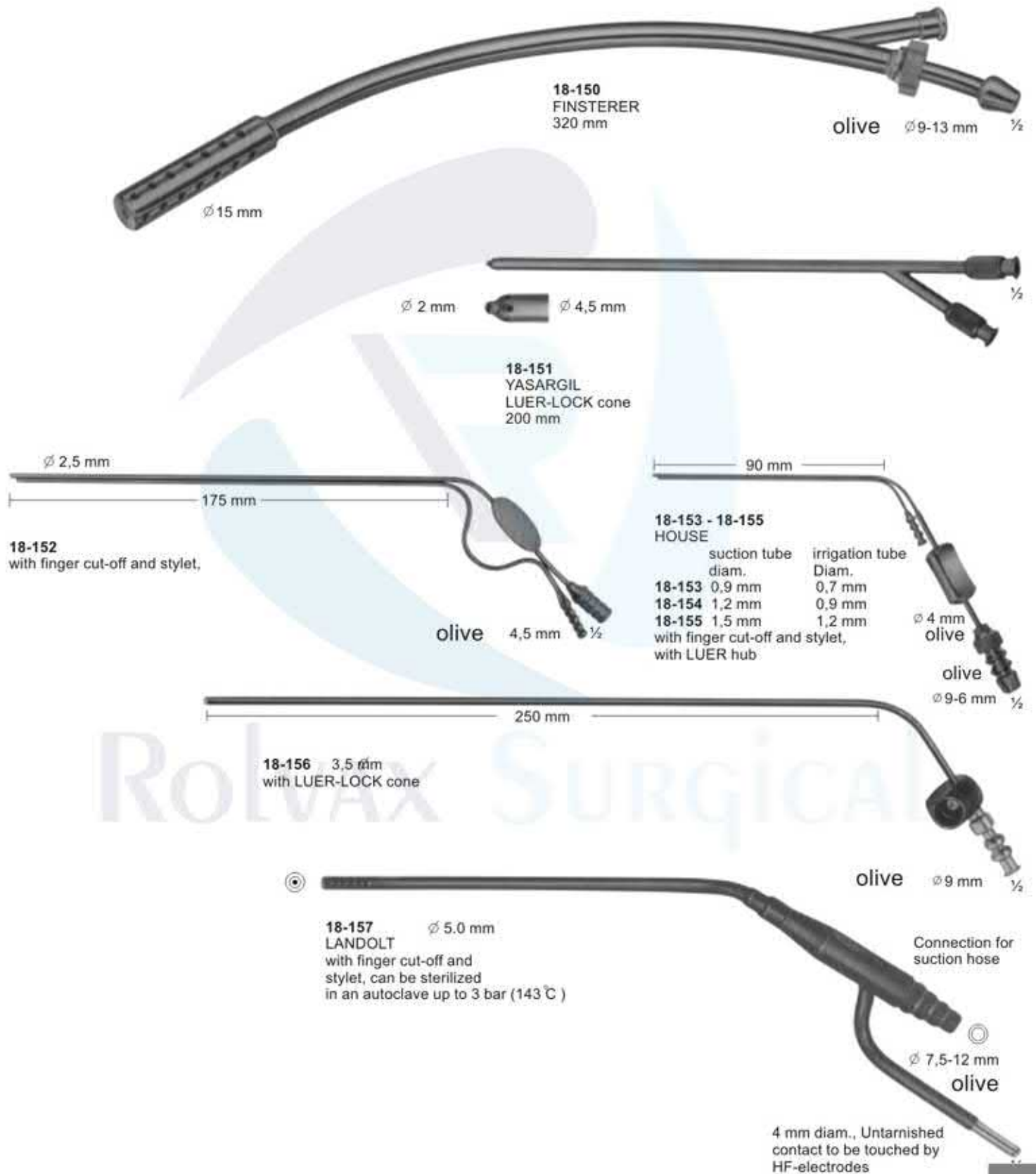

Suction Instruments

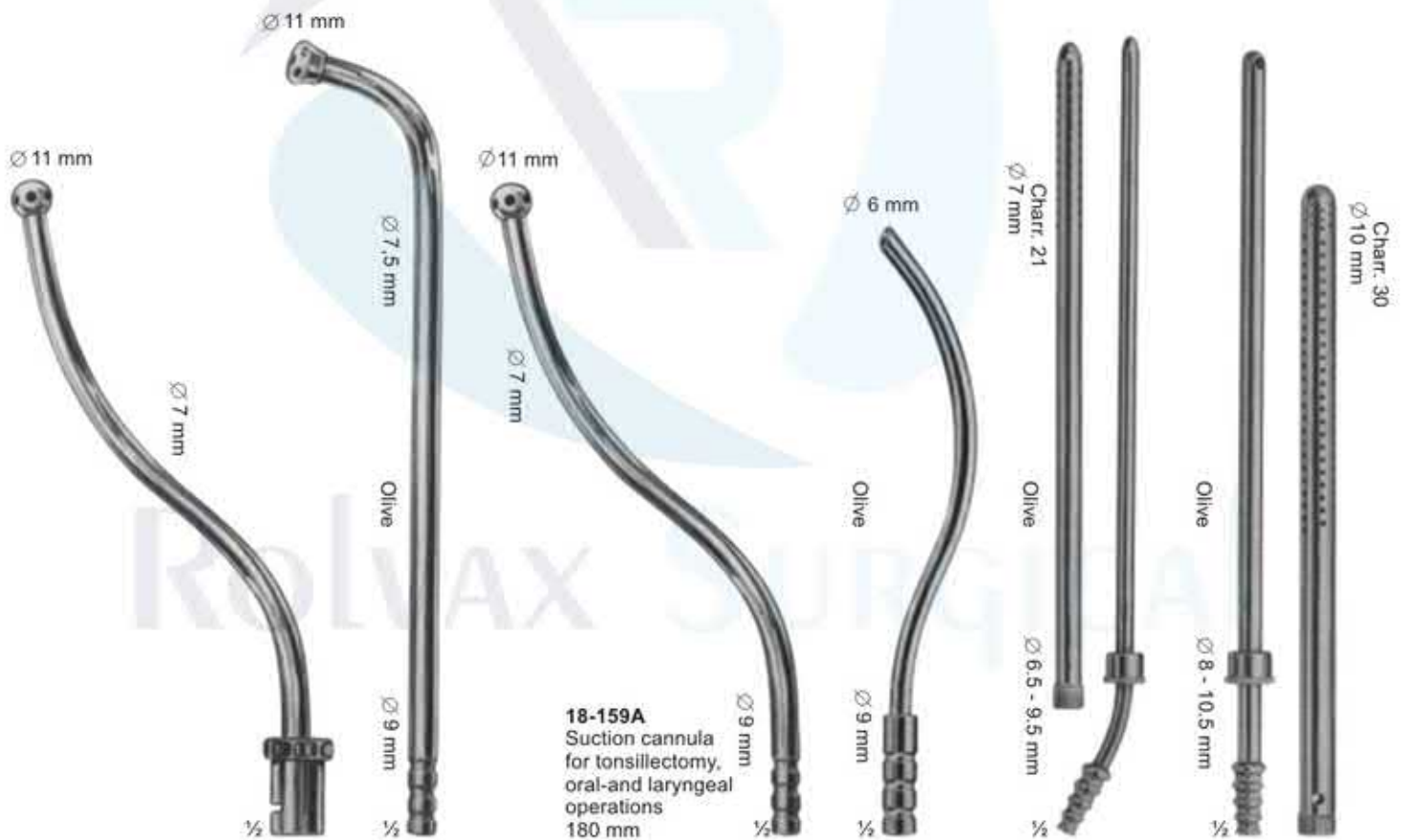

18-158
For tonsillectomy,
oral-and laryngeal
operations
180 mm

18-159
Suction cannula
for tonsillectomy,
oral-and laryngeal
operations
220 mm

18-159A
Suction cannula
for tonsillectomy,
oral-and laryngeal
operations
180 mm

18-160
S-shaped blunt cannula
for aspirating fluid from
the excretory ducts of
large glands and for
keeping the operating
area clear
170 mm

18-161
POOL
Suction cannula,
with outer tube
to be screwed off
225 mm

18-162
POOL
Suction cannula,
with outer tube
to be screwed off
225 mm

Suction Instruments

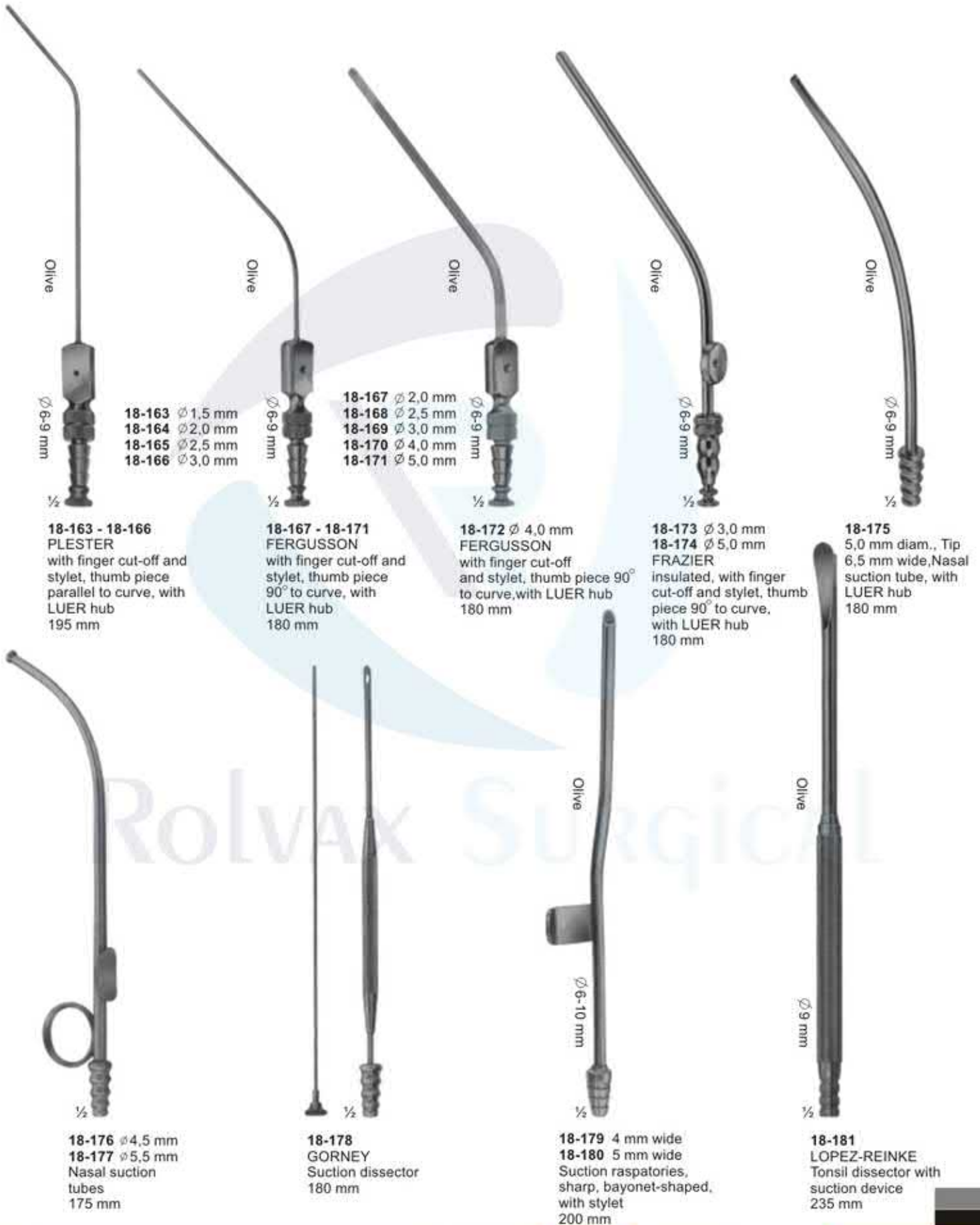

Dissection Instruments



18-182

- 1- Blow pipe .
- 2- 3 PCS .scalpel.
- 3- Dissecting forcep 13 cm.
- 4- Grooved director with tounge tie 13 cm.
- 5- Triple chain hook.
- 6- Dressing scissors probe pointed 13 cm.
- 7- Probe double 13 cm.
- 8- Zipper case inside red velvet.



18-183

- 1- Probe Double 13 cm
- 2- 2 PCS. Scalpel S.S
- 3- Grooved Director With tongue Tie 13 cm
- 4- Mayo Hegar Needle Holder 13cm
- 5- Discting Forcep 13 cm 1x2 Teeth
- 6- Dressing Forcep 13 CMS Serrated.
- 7- Dressing Scissor 13 cm S/B STR.
- 8- Dressing Scissor 13 cm S/B CVD,
- 9- Zipper Case Inside Red Velvet.



18-184

- 1- Dissecting Forcep 11.5 cm Sharp Point.
- 2- Iris Scissor
- 3- B.P Handle No. 4
- 4- Teasing Needle Sharp angular.
- 5- Blade No. 22
- 6- Thumb Forceps T.O.E 13 cm
- 7- Dissecting Scissor STR 11.5 cm
- 8- Dissecting Scissor STR 13 cm
- 9- Zipper case Inside Red Velvet

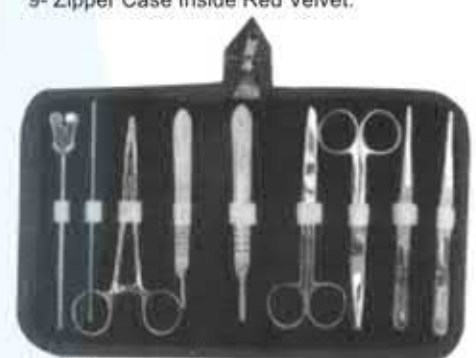

18-185

- 1- Grooved Director with Tongue Tie 14 cm
- 2- Probe Double 14cm
- 3- Mayo Hegar Needle Holder 14 cm
- 4- BP. Handle no.3
- 5- BP. Handle no.4
- 6- Dressing Scissor 14 cm S/B STR
- 7- Dressing Scissor 14 cm S/B CVD.
- 8- Dressing Forcep 1x2 Teeth 14 cm
- 9- Dressing Forcep Serrated 14 cm



18-186

- 1- Probe double 12.5 cm
- 2- Scalpel
- 3- B.P Handle No. 4
- 4- 6 PCS Blade 2 each no. 21, 22, 23
- 5- Dissecting Forcep 12.5 cm
- 6- Dissecting Forcep 11.5 cm sharp Point
- 7- Dissecting Scissor S/B STR 13 cm
- 8- Dissecting Scissor S/S STR 13 cm

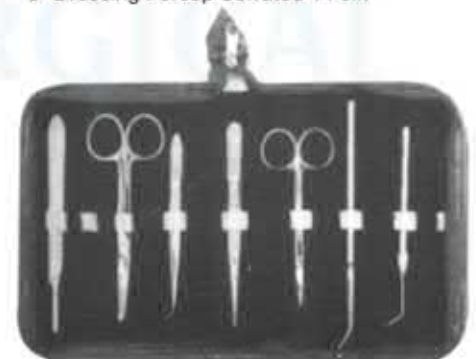

18-187

- 1- Teasing Needle with Chuck CVD.
- 2- Huber Probe
- 3- Iris Scissor
- 4- Dissecting Forcep Fine 14 cm.
- 5- Dissecting Forcep Fine CVD. 12 cm
- 6- Operating Scissor with Probe 14 cm.
- 7- B.P. Handle no. 4

Dissection Instruments



18-188

- 1- Probe with eye
- 2- Dissecting Forcep cvd fine 12 cm.
- 3- Iris Scissor
- 4- Operating Scissor S/B str 14 cm
- 5- Grooved Director and Tongue tie
- 6- Huber Probe
- 7- Triple Chain Hook
- 8- B.P Handle No. 4
- 9- B.P Handle No. 3
- 10- Teasing Needle with Chuck cvd.
- 11- Teasing Needle with Chuck str.
- 12- Dissecting Forceps Fine 14 cm.

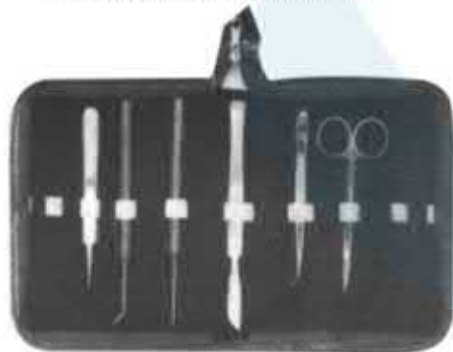

18-190

- 1- Iris Scissor STR
- 2- Dissecting Forceps CVD 12 cm.
- 3- Scalpel
- 4- Teasing Needle STR wooden handle.
- 5- Teasing Needle CVD wooden handle.
- 6- Watchmaker fine point.



18-192

- 1- Probe double end.
- 2- Grooved director and tongue tie.
- 3- B.P handle no.4
- 4- Operating scissor STR S/b14cm.
- 5- Kelly forceps STR 14cm.
- 6- Dissecting forceps thumb 13cm.

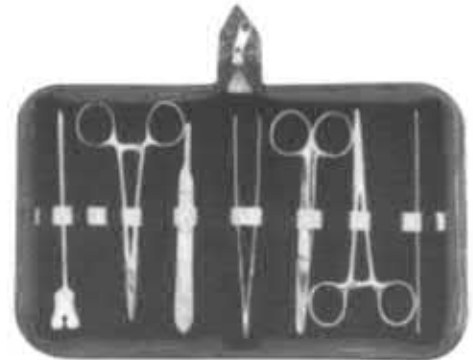

18-189

- 1- Grooved Director and Tongue tie
- 2- Mayo Hearn Needle Holder 14 cm
- 3- B.P Handle No. 4
- 4- Dissecting Forceps Thump 14 cm.
- 5- Operating Scissor S/B str 14 cm
- 6- Kelly Forcep STR 14 cm.
- 7- Probe Double end



18-191

- 1- Probe Double end
- 2- B.P Handle No. 4
- 3- Dissecting Forcep 1x2 Teeth 14 cm.
- 4- Operating Scissor S/B str 14 cm
- 5- Mayo Hearn Needle Holder 14 cm
- 6- Kelly Forcep STR 14 cm.
- 7- Operating Scissor S/B CVD 14 cm
- 8- Grooved Director and Tongue tie
- 9- Dissecting Forceps Thumb 14 cm.

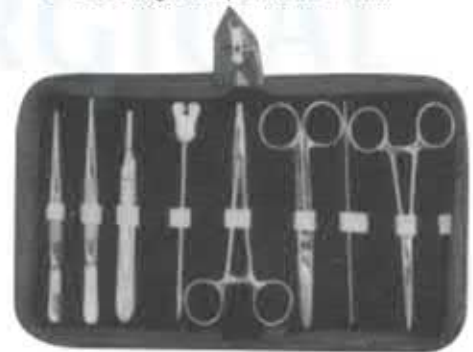

18-193

- 1- Dissecting Forceps Thumb 14 cm.
- 2- Dissecting Forcep 1x2 Teeth 14 cm.
- 3- B.P Handle No. 3
- 4- Grooved Director and Tongue tie
- 5- Mayo Hearn Needle Holder 14 cm
- 6- Operating Scissor S/B str 14 cm
- 7- Probe Double end
- 8- Kelly Forcep STR 14 cm.

Dissection Instruments



18-194

- 1- Dissecting Forcep Fine 14cm.
- 2- Dissecting Forcep Fine CVD 12cm
- 3- Dissecting Forcep with Pin 14cm.
- 4- Watchmaker Fine point
- 5- Iris scissor STR
- 6- Iris scissor CVD.
- 7- Teasing Needle holder
- 8- Teasing Needle STR.
- 9- B.P. Handle no. 3



18-195

- 1- Teasing Needle STR.
- 2- Grooved Director and Tongue Tie.
- 3- Teasing Needle CVD.
- 4- Dissecting Forcep with Pin 12 cm Fine
- 5- Operating Scissor S/B STR 14 cm
- 6- Triple Chain Hook
- 7- Probe with eye
- 8- Probe Double end
- 9- Probe and Hook
- 10- Dissecting Forcep Fine 14 cm
- 11- Iris Scissor
- 12- Huber Probe
- 13- B.P. Handle no.3
- 14- B.P. Handle no.4



18-196

- 1- Dissecting forcep fine STR with pin 12cm.
- 2- Iris scissor STR.
- 3- Probe with eye.
- 4- Probe and hook.
- 5- Operating scissor S/B STR 14cm
- 6- Triple chain hook.
- 7- B.P. handle no.4
- 8- Humber probe.
- 9- B.P.handle no.3
- 10- Teasing needle STR plasic handle.
- 11- Teasing needle CVD plasic handle.
- 12- Grooved director and tounge tie.
- 13- Probe double end.



18-197

- 1- Dissecting Forceps Thumb 14 cm.
- 2- Dissecting Forcep 1x2 Teeth 14 cm.
- 3- B.P Handle No. 3
- 4- Grooved Director and Tongue tie
- 5- Mayo Hearn Needle Holder 14 cm
- 6- Operating Scissor S/B str 14 cm
- 7- Probe Double end
- 7- Kelly Forcep STR 14 cm.

Hospital Wares



19-101 - 115
Schimmelbusch

Ø x H
sizes in mm

19-101	80 x 80
19-102	105 x 120
19-103	140 x 140
19-104	160 x 120
19-105	160 x 150
19-106	190 x 150
19-107	190 x 190
19-108	240 x 160
19-109	240 x 240
19-110	290 x 160
19-111	290 x 240
19-112	340 x 160
19-113	340 x 340
19-114	390 x 190
19-115	390 x 290



19-116
Box
120 x 65 x 13mm
(without Bulldog clamps,
without silicone tape)



19-117
Box with support
120 x 65 x 13 mm
(ohne Bulldogklemmen)



19-118
Box with support for
needle electrodes,
without instruments



19-119 - 121
50 x 25 x 4,5 mm
19-120
65 x 42 x 8 mm
19-121
75 x 25 x 4,5 mm



19-122
Ø 65mm x 15mm

Hospital Wares



19-123 - 131

	∅ x H
19-123	30 x 90 mm
19-124	50 x 100 mm
19-125	50 x 130 mm
19-126	50 x 175 mm
19-127	75 x 100 mm
19-128	75 x 130 mm
19-129	75 x 175 mm
19-130	100 x 175 mm
19-131	100 x 200 mm



19-141 - 142

- 19-141** Martin Sterilizing Forceps consisting of:
 1 Sterilizing Forceps, curved, 25 cm, without ratchet, with lid for jar
 1 jar with bottom plate (anti-tilt)
- 19-142** ditto, with 32 cm long Sterilizing Forceps



19-132 - 139

19-132	165 x 85 x 35 mm
19-133	200 x 100 x 35 mm
19-134	200 x 100 x 50 mm
19-135	230 x 130 x 50 mm
19-136	260 x 150 x 50 mm
19-137	270 x 235 x 50 mm
19-138	300 x 200 x 50 mm
19-139	325 x 275 x 50 mm



19-140
 205 x 105 x 35 mm

Round Metal Boxes and Medicine Cups



19-143 - 148

	Ø x H
19-143	75 x 60 mm
19-144	75 x 75 mm
19-145	100 x 60 mm
19-146	100 x 100 mm
19-146A	125 x 80 mm
19-147	125 x 125 mm
19-148	150 x 150 mm



19-149
25 cc

19-150
50 cc



19-151
20 cc
Medicine Spoon



19-152
Ø 75 x 12 mm
Tablet Tray



19-153
Ø 90 x 90 mm
Metal Cup



19-154
Ø 75 x 80 mm
Sputum Cup

Rolvax SURGICAL



Kidney Dish



19-155 - 157

19-155	170 x 100 x 35 mm
19-156	250 x 140 x 40 mm
19-157	275 x 150 x 45 mm

Hospital Wares

19-158 - 165

	Ø x H		
19-158	40 x 19 mm	0.05L	
19-159	61 x 30 mm	0.07L	
19-160	80 x 40 mm	0.14L	
19-161	116 x 50 mm	0.35L	
19-162	128 x 55 mm	0.45L	
19-163	147 x 65 mm	0.70L	
19-164	167 x 75 mm	1.10L	
19-165	187 x 85 mm	1.60L	

19-166 - 170

19-166	116 x 35 mm	0.30L
19-167	128 x 38 mm	0.40L
19-168	147 x 40 mm	0.50L
19-169	157 x 45 mm	0.75L
19-170	187 x 45 mm	1.00L

19-171
 Ø 110 x 28 mm 0.15L

19-172
 100 cc 0.1L

19-173 - 176
19-173 0,25L
19-174 0,50L
19-175 1,00L
19-176 2,00L

Rolvax SURGICAL

19-177
 235 x 190 x 40 mm

19-178
 Ø 220 x 70 mm

Hospital Wares



19-179
 ∅ 50 x 100 mm
 Powder Pot



19-180
 ∅ 50 x 75 mm
 Methot With Lid



19-181
 ∅ 50 x 75 mm
 Methot Without Lid



19-182



19-183



19-184



19-185 - 186

19-185 ∅ 235 mm
19-186 ∅ 310 mm

Needle Cases



19-187
Sauerbruch
210 x 125 x 17 mm



19-188
Sauerbruch
210 x 125 x 17 mm



19-189
Instruments Tray



19-190
150 x 95 x 13 mm



19-191
150 x 95 x 13 mm



19-192
150 x 95 x 13 mm



19-193
Instruments Tray



19-194
Instruments Tray



19-195
150 x 95 x 11 mm

Storing Cases



19-199 - 209

19-199	230 x 130 x 50	mm
19-200	260 x 150 x 50	mm
19-201	275 x 235 x 50	mm
19-202	300 x 200 x 50	mm
19-203	325 x 275 x 50	mm
19-204	420 x 175 x 50	mm
19-205	230 x 130 x 75	mm
19-206	260 x 150 x 75	mm
19-207	300 x 200 x 75	mm
19-208	325 x 275 x 75	mm
19-209	420 x 175 x 75	mm



19-196
Deponette
245 x 135 x 35mm



19-197
Deponette
245 x 135 x 50mm



19-198
Deponette
245 x 135 x 60mm

Sterilizing Baskets / Trays



19-210 - 212

19-210	480 x 250 x 50	mm
19-211	520 x 250 x 75	mm
19-212	520 x 250 x 100	mm



19-219
(60 x 30 x 15 cm)
Nominal dimensions



19-213 - 218

19-213	240 x 240 x 50	mm
19-214	240 x 240 x 80	mm
19-215	240 x 240 x 100	mm
19-216	480 x 260 x 50	mm
19-217	520 x 260 x 80	mm
19-218	520 x 260 x 100	mm

Scissors with Tungsten Carbide Inserts



26-101
Standard

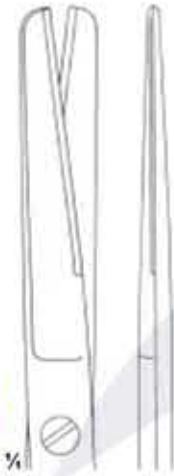

14,5cm
16,5cm
18,5cm



26-102
Standard

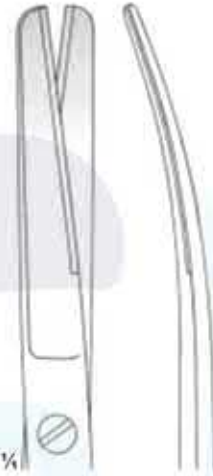

14,5cm
16,5cm
18,5cm



26-103
Standard

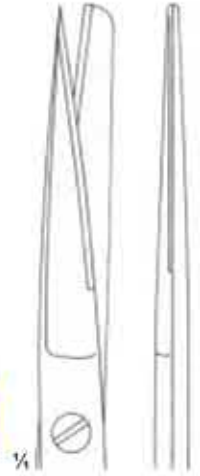

14,5cm
16,5cm
18,5cm



26-104
Standard



14,5cm
16,5cm
18,5cm



26-105
Standard



14,5cm
16,5cm
18,5cm



26-106
Standard



14,5cm
16,5cm
18,5cm

Scissors with Tungsten Carbide Inserts



26-107
Mayo-Lexer

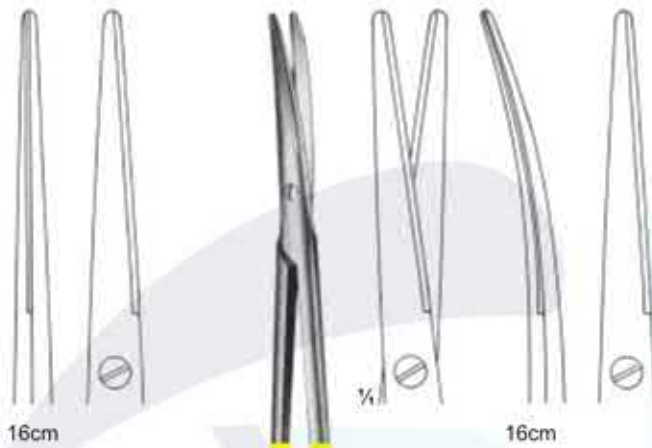

26-108
Mayo-Lexer

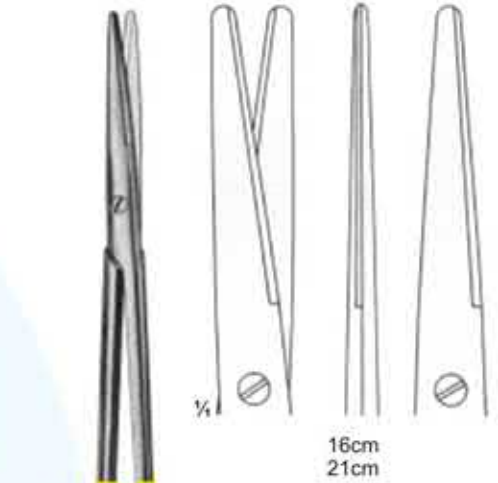

26-109
Lexer



26-110
Lexer

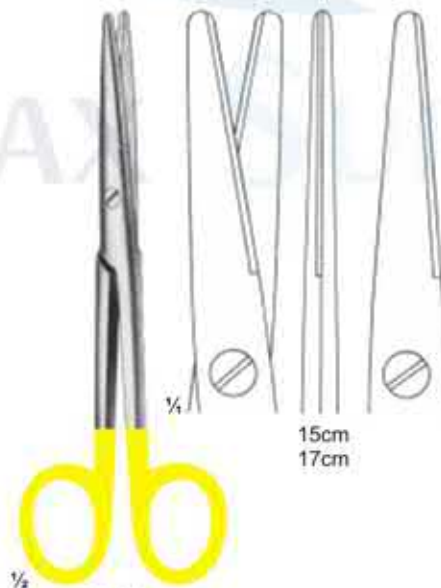

26-111
Mayo-Stille



26-112
Mayo-Stille

Scissors with Tungsten Carbide Inserts



26-113
Metzenbaum

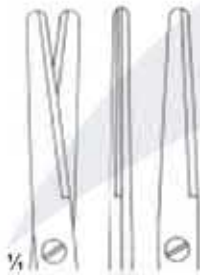

18cm 11,5cm
20cm 14,5cm
28cm 23,5cm
30cm 25,5cm



26-114
Metzenbaum



11,5cm 14,5cm
23cm 25cm



26-115
Metzenbaum

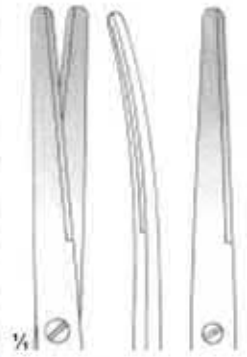

18cm 20cm
28cm 30cm



26-116
Metzenbaum-Fino



14cm 18cm 20cm
23cm 25cm 28cm



26-117
Metzenbaum-Fino

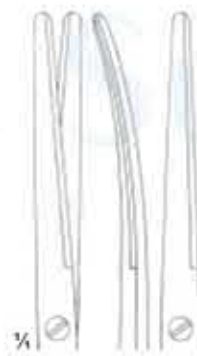

14cm 18cm 20cm
23cm 25cm 28cm



26-118
Metzenbaum-Fino



14cm 18cm
20cm 23cm

Scissors with Tungsten Carbide Inserts



1/2
26-119
Metzenbaum-Fino

14cm 18cm
20cm 23cm



1/2
26-120
Metzenbaum-Fino

18cm
20cm
23cm



1/2
26-121
Metzenbaum-Fino

18cm
20cm
23cm



1/2
26-122
Metzenbaum

20cm
23cm



1/2
26-123
Mayo

14,5cm
17cm
23cm

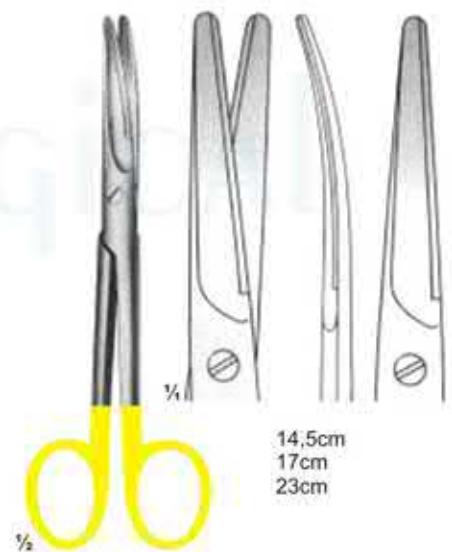

1/2
26-124
Mayo

14,5cm
17cm
23cm

Scissors with Tungsten Carbide Inserts



Scissors with Tungsten Carbide Inserts

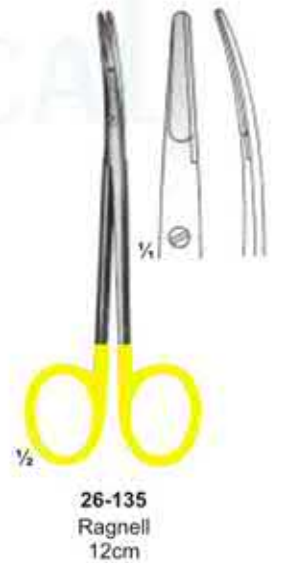
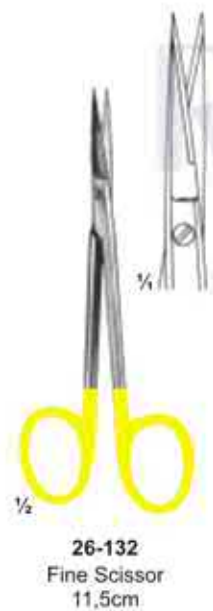
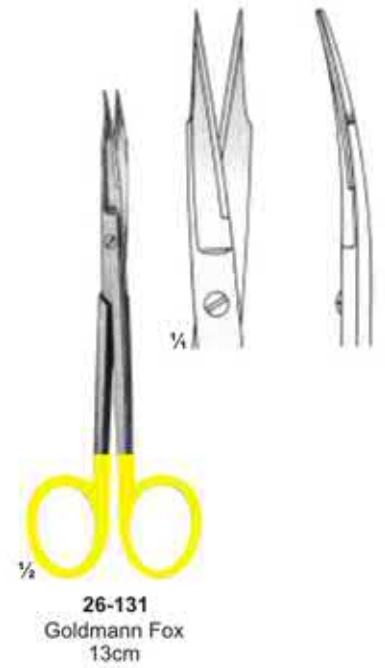

Scissors & Dissecting Forceps with Tungsten Carbide Inserts



26-136
Universal
12cm



26-137
Ligature Scissors
1 Black & 1 Goldplated ring

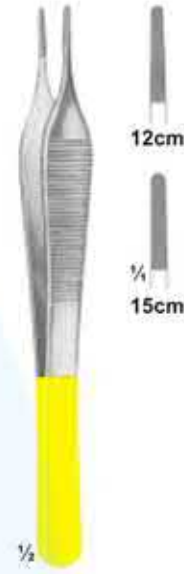

26-138
Adson



26-139
Cushing
17,5cm



26-140
Cushing
18cm



26-141
Cushing-Taylor
18cm



26-142
Dissecting Forceps
15cm



26-143
Semken
15cm

Dissecting Forceps and Needle holders with

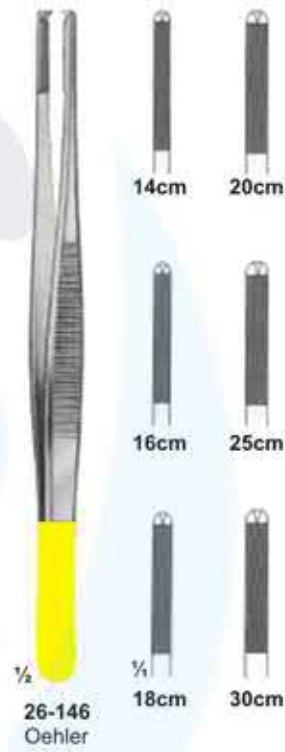
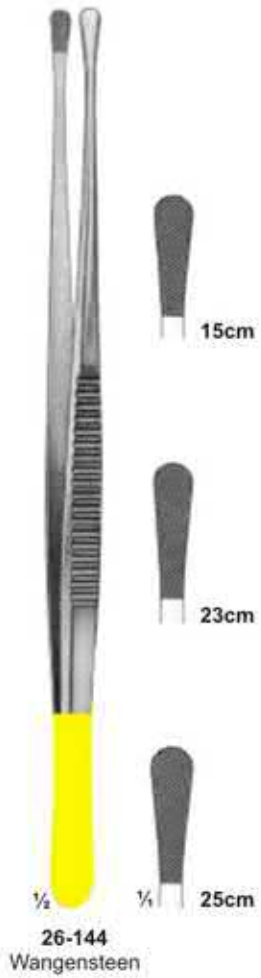

Needle holders with Tungsten Carbide Inserts



26-152
Arruga
16cm



26-153
Castroviejo
13cm



26-154
Hegar
20cm 24cm

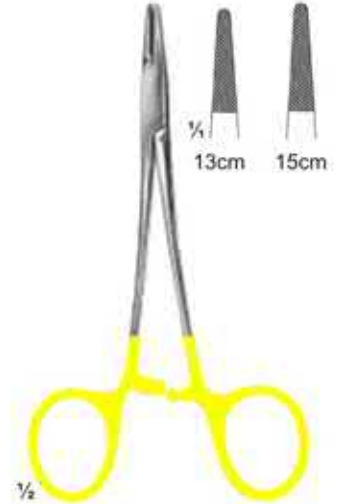
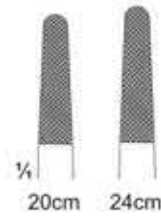

26-155
Halsey
13cm 15cm

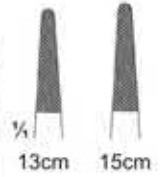

26-156
Mayo-Hegar
16cm 18cm 20cm
24cm 26cm 30cm



26-157
De-Bakey
18cm 20cm 23cm
26cm 31cm 37cm

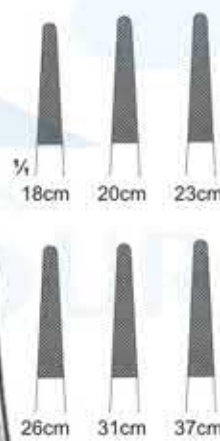

26-158
Hegar-Vascular
14cm 18cm
20cm 23cm



Needle holders with Tungsten Carbide Inserts



26-159
Bozemann-Wertheim
20cm 24cm 26cm



26-160
Stratte
22cm 23cm

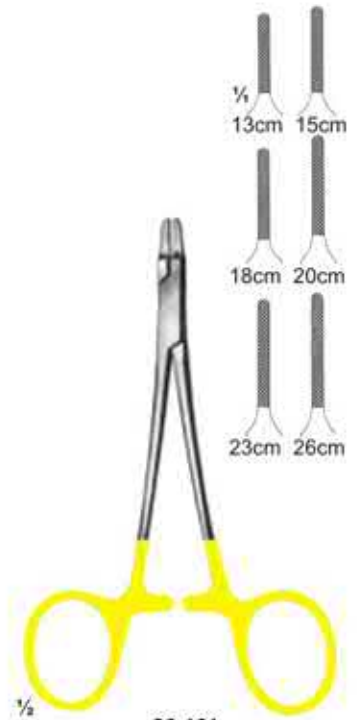

26-161
Ryder
13cm 15cm 18cm
20cm 23cm 26cm



26-162
Ryder-Vascular
13cm 15cm 18cm
20cm 23cm 26cm



26-163
Martin
15cm 17cm 20cm



26-164
Sarot
18cm 20cm 26cm

Needle holders with Tungsten Carbide Inserts



26-165
Finochietto
27cm



26-166
Heaney
20cm 24cm



26-167
Mathieu
14cm 17cm
20cm

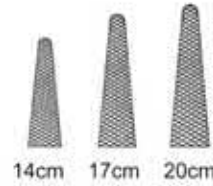

26-168
Mathieu
12cm
20cm 23cm



26-169
Mathieu-Kosher
14cm 17cm
20cm 24cm



26-170
Mathieu-Kosher
17cm
20cm 24cm



26-171
Mathieu-Vascular
17cm
20cm 24cm

Needle holders with Tungsten Carbide Inserts



26-172
Mathieu-Ryder
17cm
20cm 24cm



26-173
Lichtenberg
20cm



26-174
Langhals
20cm 25cm



26-175
Lichtenberg
20cm 25cm



26-176
Luehty-Beck
20cm 25cm



26-177
Luehty-Beck
20cm 25cm



26-178
Langebeck
18cm
20cm 23cm

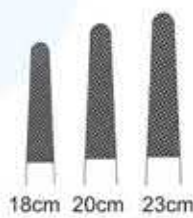

26-179
Langebeck-beck
18cm
20cm 23cm

Wire Cutting Plier With T.C. Inserts



26-180
TOENNIS
 Elastic pattern for
 dura-or intestinal suture
 180 mm



26-181
 Cutting Plier
 12 cm



26-182
MULLAR CLAUS
 22 cm



26-183
 Plier
 17.5 cm

Alphabetical Index

A			
ABRAHAM, tonsil knife	13	BRUNS, plaster scissor	64
ADSON, forceps	33	BRYANT, sponge forceps	43
ADSON, forceps	37	BROPHY, Tissue Forceps	38
ALLIS, artery traction forceps	47	BROWN, Tissue Forceps	39
ALLIS, intestinal grasping forceps	86	BUCHS, retractors	75
ALY, aesthesiometer	01	BUCHWALD, tongue depressor	04
AMPUTATING KNIVES	12	BUCK, neurological hammer	01
ANDREW, tongue depressor	04	BUMM, ovum forceps	230
ANESTOPHON, stethoscope	02	BUCK, Ear Curettes	110
ARRUGA, forceps	37		
ARRUGA, needle holder	61	C	
ASCH, biopsy curettes	112	CASPAR, retractor	75
AUFRIEHT, rasps	138	CASPAR, Micro scissor 115mm	16
AYRE, cone knife, 235mm	13	CASTROVIEJO, tissue forceps	37
ADSON - BROWN, Tissue Forceps	39	CASTROVIEJO, micro spring scissor	15
ADSON, Haemostatic Forceps	52	CASTROVIEJO, needle holder	61
ANGLE, Wire Cutters Cutting Scissors	151	CASTROVIEJO, eye scissor 110mm	15
		CASTROVIEJO, eye scissor 115mm	15
B		CATLIN, amputating knife 160mm	12
BABCOCK, intestinal grasping forceps	86	CALIPER, Examination & Measuring Instruments	10
BABY-ALLIS, artery traction forceps	47	CARREL, Haemostatic Forceps	51
BACKHAUS, towel clamps	48	CARROLL, Examination & Measuring Instruments	10
BACKHAUS-KOCHER, towel clamps	48	CASPAR, Rongeurs	133
BAILEY, rib spreaders	128	CASPAR, Rongeurs	134
BAKES, gall duct dilators	95	CASTROVIEJO, Examination & Measuring Instruments	10
BALFOUR, abdominal retractors	85	CHAPUT, artery traction forceps	47
BALFOUR-BABY, abdominal retractors	84	CLOWARD, lamina Spreaders	83
BANE-HARTMANN, bone rongeurs	144	CLAUS PLIER, Wire Cutting Plier With T.C. Inserts	187
BARTH, bone curettes	139	CLAUS PLIER, Wire Cutting Plier With T.C. Inserts	187
BABY-MOSQUITO, Haemostatic Forceps	51	COAKLEY, antrum trocars	100
BABY-ROUX, Retractors	73	COLLIN, intestinal grasping forceps	86
BABY-SENN-MILLER, Retractors	73	COLLIN, rib shears	126
BEEBE wire scissor	29	COLLIN, sponge and dressing forceps	44
BEER, cilia forceps	42	COLLIN, tongue forceps	05
BENGOLEA, delicate forceps	50	COLLIN, vaginal spatula	101
BERGER, biopsy forceps	115	CONE KNIFE 235mm11	13
BERLINER, percussion hammer	01	CONVERSE, fine wound retractor	69
BENDING PLIERS, Wire Holding forceps	150	COOLEY, multi purpose clamps	122
BERTILLON, Examination & Measuring Instruments	10	COTTLE, retractors	71
BIEMER, vein scissor	16	COTTLE, nasal scissor	25
BISHOP-HARMON, forceps	37	COTTLE, fine wound retractor	69
BIEMER, Suction Instruments	158	COTTLE, mallets	140
BLAKE, gall stone forceps	96	COLLIN, Examination & Measuring Instruments	10
BLUMENTHAL, bone rongeurs	144	COLLIN, Intestinal Grasping Forceps	46
BONNEY, tissue forceps	41	COLLIN, Retractors	73
BOSE, tracheal hooks	119	COLLIN-HARTMANN, Retractors	73
BOWLES, stethoscope	02	COTTLE, Forceps, Bayonet - Shaped	40
BOYS-ALLIS, artery traction forceps	47	COTTLE, Nasal Specula	91
BOZEMANN, dressing forceps	108	CRILE, Haemostatic Forceps	52
BOYNTON, Needle Holders	47	CRILE, Haemostatic Forceps	52
BRAUN, artery traction forceps	107	CRILE, Retractors	73
BRAUN, uterine probes	28	CUTTING PLIER, Wire Cutting Plier With T.C. Inserts	187
BRAUN-STADLER episiotomy scissor	31	CRAFOORD, haemostatic forceps	50
BRAUN-STADLER, bandage scissors	102	CRILE, needle holder	63
BRIESKY, vaginal specula	66	CUSCO, vaginal specula	101
BRODIE, probes	34	CUSHING, wound and vein retractor	71
BROPHY, dissecting forceps	04	CUSHING, dissecting forceps	34
BRUENINGS, tongue depressor	13	CUSHING-KOCHER, retractors	71
BRUNINGS, tonsil knife, 215mm	76	CZERNY, gall stone forceps	96
BRUNNER, retractors	126	CZERNY, retractors	72
BRUNNER, rib shears	31		

Alphabetical Index

D		F	
DAVIDSON, scapula retractors	77	FARABEUF, Retractors	73
DAVIS, vascular spatulas	120	FEILCHENELD, splinter forceps	42
DANDY, Haemostatic Forceps	51	FERGUSSON, haemorrhoidal forceps	93
DE BAKEY, forceps	36	FERGUSSON, suction instrument	163
DE BAKEY, anastomosis clamps	89	FERGUSSON-ACKLAND, mouth gag	05
DE BAKEY, anastomosis clamps	125	FINOCHIETTO, forceps	58
DE BAKEY, arteriotomy scissor	22	FINOCHIETTO, rib spreader	127
DE BAKEY, vana cava clamps	123	FINSEN, tracheal hooks	119
DE BAKEY, multi purpose clamps	122	FIBER OPTIC, laryngoscopes	09
DE BAKEY, retractors	82	FINGER NAIL DRIL, Finger Nail Instruments	155
DE BAKEY, atraumata	121	FINGER RING SAW, Finger Nail Instruments	155
DEAN, nasal and tonsil scissor	25	FINSTERER, Suction Instruments	161
DEAVER, retractors	77	FLAT-NOSED PLIERS, Wire Holding forceps	150
DEAVER, surgical scissor (flat lock)	21	FOERSTER-BALLENGER, Tissue Grasping Forceps	45
DE-BAKEY, bulldog clamps	49	FORCEPS, Finger Nail Instruments	155
DEJERINE, percussion hammer	01	FOREGGER, laryngoscopes	09
DELICATE DISSECTING FORCEPS	33	FOMON, nasal scissor	19
DELICATE SCISSORS, blunt points	19	FORD-BOWLES, stethoscope	02
DELICATE SCISSORS, sharp points	18	FOWLER, tonsil knife	13
DELICATE SCISSORS, sharp points	19	FRANCKE, blood lancet	06
DENHARDT, mouth gag	05	FRAZIER, fine wound retractor	69
DENIS-BROWENE, intestinal forceps	41	FRAZIER, suction instruments	163
DERRA, multi purpose clamps	122	FREER, fine wound retractor	69
DESCHAMPS, ligature needles	65	FREER, vascular spatulas	120
DESJARDINS, gall duct forceps	95	FRENZEL, tongue depressor	04
DESJARDINS, gall stone forceps	96	FRICKE, haemostatic forceps	56
DESJARDINS, gall stone scoops	95	FRITSCH, retractor	79
DESMARRES, wound and vein retractors	71		
DEMEL, Cerclage Instruments	148	G	
DIAGNOSTIC SETS	07	GALLAHER, rasp	126
DICK, vaginal clamps and compression forceps	59	GELPI, special retractors	82
DIEFFEBACH, bulldog clamps	49	GELPI, vaginal retractors	105
DINGMANN, bone holding forceps	142	GERALD, dissecting forceps	34
DISSECTING KNIVES	11	GIERTZ-STILLE, rib shears	126
Dissection Instruments	164	GILL, tissue forceps	37
Dissection Instruments	165	GILL-HESS, tissue forceps	37
Dissection Instruments	166	GILLIES, fine wound retractor	69
DITTEL, metal bougies	80	GILLIES, needle holder	63
DOYEN, abdominal retractors	79	GLOVER, bulldog clamp	49
DOYEN, intestinal clamps	87	GLUCK, rib shears	126
DOYEN, ovum forceps	230	GOOD, tonsil scissors	25
DOYEN, probes	66	GORNEY, suction instruments	163
DOYEN, towel clamps	48	GOSSET, abdominal retractors	84
DOYEN, vaginal specula	104	GRAEFE, fine wound retractor	69
DUROGRIP, Wire Holding forceps	149	GRAVE, vaginal specula	102
DUROTIP, Cutting Pliers	152	GROSS, dressing forceps	43
DUROTIP, Cutting Pliers	153	GUEDEL-NEGUS, laryngoscope	08
DUROTIP, Wire Cutters Cutting Scissors	151	GUTHRIE, fine wound retractor	69
DUVAL-COLLIN, Intestinal Grasping Forceps	46	GUYON, kidney clamps	97
DUPLAY, sponge and dressing forceps	43	GERALD, Tissue Forceps	38
DUVAL, intestinal forceps	41	GILLIES, Tissue Forceps	38
		GOLDSMITH, Nasal Specula	91
E		GRAEFE, Tissue Forceps	39
EISELSBERD, needle holder	63	GRAEFE, Tissue Forceps	39
ELSCHING, forceps	37	GRUENWALD, Forceps, Bayonet – Shaped	40
ENGL.MOD, towel clamps	48		
EPPENDORF, biopsy forceps	115	H	
ESMARCH, cloth and plaster scissors	31	HALLE, vascular spatulas	120
EISELSBERG-MATHIEU, Needle Holders	64	HALSTED-MOSQUITO, haemostatic forceps	50
EXTRACTION PLIERS, Wire Holding forceps	150	HARTMANN, intestinal clamps	87

Alphabetical Index

HARVEY, plate scissors	29	KELLY, tissue grasping forceps	44
HAJEK-KOFLER, Punches	130	KERN-LANE, bone holding forceps	143
HALSTED, Haemostatic Forceps	52	KERRISON-JACOBY, punches	129
HALSTED-MOSQUITO, Haemostatic Forceps	51	KERSTING, anastomosis forceps	89
HARTMANN, Ear Polypus Forceps	112	KELLY, Haemostatic Forceps	51
HARTMANN-HALLE, Nasal Specula	91	KERRISON, Punches	130
HARTMANN-HERZFELR, Ear Polypus Forceps	112	KILLIAN, bone shear	26
HARTMANN-HOFFMAR, Ear Polypus Forceps	112	KILLIAN, rectal spatula	90
HARTMANN-WULLSTEIN, Ear Polypus Forceps	112	KILNER, fine dissecting scissors	22
HARVEY, Wire Cutters Cutting Scissors	151	KILNER, fine wound retractor	69
HEANEY, needle holder	62	KILNER, dissecting scissor	22
HEGAR, needle holder	62	KILLIAN, Nasal Specula	90
HEGAR-OLSEN, needle holder	63	KIRSCHNER, Cutting Pliers	154
HEGER, uterine dilators	106	KIRSCHNER, Wire Extension	147
HEISS, haemostatic forceps	50	KOCHER, Haemostatic Forceps	52
HEISS, dressing forceps	58	KOCHER, Haemostatic Forceps	54
HEISTER, mouth gag	05	KOCHER-OCHSNER, Haemostatic Forceps	55
HENING, plaster spreader	157	KLIMA ROSEGGER, trocars	100
HERGET, biopsy forceps	113	KOCHER, retractor	71
HERTZLER, abdominal retractors	84	KOCHER, bladder retractors	99
HERTZLER, rib spreaders	127	KOCHER, bone retractor	74
HESS, tissue forceps	37	KOCHER, retractors	75
HEYMANN-KNIGHT, scissors	25	KOLLE, blood lancet	06
HEYWOOD-SMITH, ovum forceps	109	KONIG, elevators	135
HEYWOOD-SMITH, sponge holding forceps	44	KONIG, raspatories	137
HEYWOOD-SMITH, tongue forceps	05	KONISATION SMESSER, retractors	57
HOLLOW NEEDLE, Suction Instruments	159	KRAUSE, biopsy tip	115
HOUSE, Suction Instruments	161	KRISTELLER, vaginal specula	102
HUBER, biopsy forceps	115	KRISTELLER, vaginal specula	103
HUNT, tumor & vessel forceps	32	KRONECKER, suture instruments	65
HUNTER, splinter forceps	42	KRONLEIN, haemostatic forceps	56
		KUMMEL, intestinal spatula	80
I		L	
INGE, lamina spreaders	83	LABORDE, tracheal dilators	119
INTEROSSEOUS, cartilage knife	12	LAHEY, artery traction forceps	47
IVES-FANSLER, anoscopies	92	LAHEY, gall duct forceps	94
J		LANE TRETOWAN, bone levers	136
JACKSON BURROWS, retractors	82	LANE, bone holding forceps	143
JACOBSON, bone curettes	139	LANE, bone levers	136
JACOBSON, needle holder	61	LANE, tissue forceps	41
JAEGAR, fine wound retractor	69	LANE, towel clamps	48
JAMESON, dissecting scissor	22	LANGE-HOHMANN, bone levers	136
JAMESON, needle holder	62	LANGENBACK, bone levers	135
JANSEN, bone curettes	139	LANGENBECK, with triangle handle	70
JANSEN, bone rongeurs	144	LANGENBECK, flap knife	12
JOHNS-HOPKING, bulldog clamps	49	LARYNGEAL MIRRORS	06
JOLL (FRIEDMAN), retractors	82	LAWRENCE, ligature forceps	58
JOLL, vaginal retractors	105	LANDOLT, Suction Instruments	160
JONES, towel clamps	48	LANDOLT, Suction Instruments	161
JOSEPH, bone file	138	LANGENBECK, Ear Curettes	110
JOSEPH, dura and skin retractor	69	LEBSCHKE, rib shears	126
JOSEPH, raspatories	137	LEGUEU, bladder retractors	99
JUDD-MASSON, bladder retractors	99	LEKSELL-STILLE, bone rongeurs	145
JANSEN, FORCEPS, Bayonet - Shaped	40	LERICHE, intestinal spatula	80
K		LEWIS, bone file	138
KADER, intestinal spatula	80	LISTER, bandage scissor	30
KALT, needle holder	61	LISTER, cloth scissor	30
KELLY, ovum forceps	109	LISTER, sponge forceps	43
KELLY, anoscopies	92	LISTON, bone cutting forceps	146

Alphabetical Index

LOCKHART-MUMMERY, probes	66	MULLER, dura and skin retractor	69
LOCKWOOD, Intestinal Grasping Forceps	46	MURPHY, head band	03
LUCAE, FORCEPS, Bayonet – Shaped	40	MUSEUX, tissue grasping forceps	47
LUER, Retractors	73	N	
LOCKLIN, delicate scissor	25	NASAL SCISSORS	25
LOPEZ-REINKE, suction instruments	163	NAUJOKS wire scissors	29
LOWER, gall duct forceps	94	NAIL SPLITTING, Finger Nail Instruments	155
LOWMAN, bone clamps	143	NEEDLE HOLDER, for micro surgery	48
LOWMAN-GERSTER, bone clamps	143	NEGUS, tonsil forceps	57
LOWMAN-HOGLUND, bone clamps	143	NELATON, probes	66
LUCAS, gouges	141	NELSON, lung dissecting forceps	41
LUER-KORTE, gall stone scoops	80	NISSEN, gall duct forceps	94
LURE, bone rongeurs	144	NOTO, ovum forceps	109
M		NOTO, sponge holding forceps	44
MAGILL, laryngoscope	07	NOVAK-SCHOECKAERT, biopsy curettes	111
MALTZ, rasps	138	NOYES, micro spring scissor	15
MANNERFELT, osteotomes	141	O	
MANNERFELT, retractors	70	OLIVECRONA, dura scissors	24
MARTIN, uterine probes	107	OLIVECRONA, trigeminal knife	13
MARTINI, bone curettes	139	OTOSCOPE SETS	07
MASING, retractors	71	OTOSCOPE, Diagnostic Sets	07
MASSON, needle holder	62	P	
MASSON-LUETHY, needle holder	62	PARTSCH, raspatories	137
MATHIEU, retractors	72	PARTSCH, gouges	141
MAYO, dissecting scissors	23	PARTSCH, raspatories	137
MAYO, uterine probes	107	PAYR, pylorus clamps	86
MAYO-HARRINGTON, dissecting scissors	23	PEAN, haemostatic forceps	57
MAYO-NOBLE, dissecting scissors	23	PEAN, haemostatic forceps	51
MAYO-STILLE, dissecting scissors	23	PEAN, kidney clamps	97
MARTIN, Nasal Specula	90	PEDERSON, vaginal specula	102
MATHIEU, Needle Holders	64	PEET, splinter forceps	42
MATHIEU-STILLE, Needle Holders	64	PELKMANN, uterine dressing forceps	108
MC INDOE, forceps	34	PERKINS, self retaining retractors	81
MC KENTY, raspatories	137	PIERCE, trocars	100
MEAD, mallets	140	PINARD, wooden stethoscope	02
MC INDOE, Tissue Forceps	38	PLESTER, retractors	81
MCINTOSH, laryngoscopes	09	PLESTER, suction instruments	163
MEDIUM, Dissecting Forceps	35	POOL, suction instruments	162
MICRO-HALSTED, Haemostatic Forceps	51	POTTS-SMITH, cardiovascular scissor	24
MILLIN, Needle Holders	64	PROBES	67
MICHEL, laryngeal mirrors	06	PARKER, Retractors	73
MICRO SCISSORS, laterally angled	17	PEAN, Haemostatic Forceps	52
MICRO-ADSON, forceps	33	PEAN, Haemostatic Forceps	53
MICRO-ADSON, forceps	37	PEAN, Haemostatic Forceps	54
MIDDELDORPF, retractors	75	PENNINGTON, Tissue Grasping Forceps	45
MIKULICZ, tissue forceps	57	PROVIDENCE-HOSPITAL, Haemostatic Forceps	51
MIKULICZ, intestinal spatula	80	Q	
MIKULICZ, retractors	78	QUERVAIN, bone levers	113
MILLER, laryngoscope	08	R	
MILLIN, bladder retractors	99	RABINER, neurological hammer	01
MIXTER, ligature forceps	58	RANDALL, biopsy curettes	111
MOD.USA, plaster spreader	127	RANDALL, kidney stone forceps	98
MORRIS, anastomosis clamps	89	RECAMIER, uterine scoops	116
MOYNIHAN, haemostatic forceps	57	REYNOLDS, dissecting scissors	22
MOYO-HEGAR, needle holder	62	RICHTER, vaginal retractors	105
MOD. WIEN, Nasal Specula	91	ROCHESTER-CARMALT, haemostatic forceps	57
MOLTGEN, Examination & Measuring Instruments	10	ROEDER, towel clamps	48
MULLAR, Wire Cutting Plier With T.C. Inserts	187		
MULLER LIGATURE FORCEPS	49		
MULLER VESSEL CLIPS	49		

Alphabetical Index

ROUX, retractors	72
RUDD, haemorrhoidal ligator	93
RUMEL, dissecting forceps	58
RUSS-MODELL, tissue forceps	41
ROHRSCHEIDER, needle holder	61
ROLLET, dura and skin retractor	69
ROSER KONIG, mouth gag	05
RAMPLEY, Tissue Grasping Forceps	45
RANKIN, Haemostatic Forceps	52
REILL, Cutting Pliers	152
REPLACEMENT LAMP, laryngoscopes	09
ROCHESTER-OCHSNER, Haemostatic Forceps	54
ROCHESTER-PEAN, Haemostatic Forceps	53
ROSE, Retractors	73
ROUND PLIERS, Wire Holding forceps	150

S

SAENGER, ovum forceps	118
SAMII, tumor grasping forceps	32
SATINSKY, vena cava scissors	24
SAUPE, cilia forceps	42
SCALPEL HANDLES	14
SCHAAF, cilia forceps	42
SCHAEDEL, towel clamps	48
SCHEINMANN, biopsy forceps	115
SCHIMMELBUSCH, ether mask	05
SCHMID, vascular spatulas	120
SCHOEMAKER-LOTH, needle holder	63
SCHOENBORN, retractors	71
SCHRODER, uterine scoops	116
SCHUMACHER, rib shears	126
SCHUMACHER, umbilical scissors	28
SCHUMASHER, biopsy forceps	114
SCOVILLE-RICHTER, retractors	67
SEGOND, myomatome	13
SEIDL, vaginal specula	102
SEIDL-DBP, biopsy forceps	114
SELLORS, rib spreaders	128
SEMKEN, dissecting forceps	34
SEMKEN, tissue forceps	37
SENN-MILLER, Retractors	73
SEUTIN, plaster scissor	31
SHAPLEIGH, Ear Curettes	110
SIMON, uterine scoops	116
SIMPLEX, tongue depressor	04
SIMPSON, uterine probes	107
SIMPSON-BRAUN, obstetrics forceps	117
SIMS, gynaecology scissors	27
SIMS, vaginal specula	102
SIMS, rectal specula	90
SIMS, uterine probes	107
SMOOTH JAWS FORCEPS	34
ST.MARTIN, tissue forceps	37
STEMBERG, tongue depressor	04
STIEGLITZ, splinter forceps	42
STILLE, bone rongeurs	145
STILLE-AESULAP, plaster shears	156
STILLE-RUSKIN, bone rongeurs	145
STRACK, wire scissor	29
STRASSBURGER Tissue forceps	41
STANDARD, Dissecting Forceps	35
STANDARD, Tissue Forceps	39

STERBERG, Retractors	
STRULLY, cardiovascular scissors (pointed)	24
SUCTION INSTRUMENTS	162
SURGICAL SCISSORS, incision	21
SURGICAL SCISSORS, serrated	20
SURGICAL SCISSORS, slender type	20
SURGICAL SCISSORS, standard	20
SURGICAL SCISSORS, standard	20
SUTURING INSTRUMENT SET	68
SYSTRUNK, nail splitting scissors	21
SPENCER-WELLS, Haemostatic Forceps	
SYSTRUNK, Finger Nail Instruments	

T

TAKAHASHI, rongeur	112
TAYLOR, percussion hammer	01
TAKAHASHI, Rongeurs	132
THOREK, cardiovascular scissors	24
THORPE, corneal forceps	33
TIECK-HALLE, Nasal Specula	90
TOENNIS, Wire Cutting Plier With T.C. Inserts	187
TOWNLEY, Examination & Measuring Instruments	10
TOBOLD, tongue depressors	04
TOENNIS ADSON, dissecting scissors	22
TOENNIS, dissecting scissors	22
TOENNIS, fine wound retractor	69
TOENNIS, vascular spatulas	120
TOENNIS, needle holder	63
TRELAT, raspatories	137
TRIGEMINAL KNIFE	13
TROCARS	100
TROEMNER, percussion hammer	01
TROUSSEAU, tracheal dilators	119
TROCAR, Suction Instruments	159
TROELTSCH, FORCEPS, Bayonet - Shaped	40
TUFFIER, rib spreaders	127
TUTTLE, lung dissecting forceps	41

U

UMBILICAL CORD SCISSORS	28
UNIVERSAL BANDAGE SCISSORS	30
UNIVERSAL TROCARS	100
US-ARMY, retractors	72

V

VANNAS, micro spring scissors	15
VERNIER, Examination & Measuring Instruments	10
WISE GRIP, Wire Holding forceps	150
VOLKMANN, bone curettes	139
VOLKMANN, bone retractors	74

Alphabetical Index

W

WANGENSTEEN, needle holder	62
WARTENMERG, pinwheel	01
WAGNER, Rongeurs	134
WAUGH, Tissue Forceps	38
WEBER, anastomosis clamps	124
WECKER, eye scissors	15
WEIL-BLAKESLEY, rongeurs	112
WEITLANER, self retaining retractors	81
WERTHEIM, gynaecology scissors	27
WERTHEIM, clamps and forceps	59
WERTHEIM-CULLEN, vaginal clamps	60
WIEDER, tongue depressor	04
WEIL-BLAKESLEY, Rongeurs	132
WILLIGER, bone curettes	139
WILLIGER, elevators	135
WILLIGER, raspatories	137
WINTER, ovum forceps	118
WILDE, Forceps, Bayonet – Shaped	40
WOLFF, plaster breakers	157
WULLSTEIN, retractors	81
WULLSTEIN, Suction Instruments	160

Y

YASARGIL, needle holder	61
YASARGIL, tumor grasping forceps	32
YASARGIL-SAMII, tumor grasping forceps	32
YASARGIL, Suction Instruments	160
YASARGIL, Suction Instruments	161
YASARGIL, micro scissors	17
YEOMAN, biopsy forceps	113
YOUNG, tongue forceps	05
YOUNG– HRYNTSCHAK, Needle Holders	64
YOUNG-MILLIN, Needle Holders	64

Z

ZENKER, ligature	58
ZENKER, retractors	77
ZIEGLER, head band	03
ZIEGLER, head mirror	03



Rolvax SURGICAL

Manufacturer & Exporter of Surgical Instruments

**Address: Street #04 Muslim pura khadim Ali
road kotli behram, Sialkot. Pakistan**

Phone: +923147564341

Mobile: +923001464444

Email: info@Rolvaxsurgical.com